



# Sur-Gard System I

Operating Manual  
version 1.0



**WARNING:** This manual contains information regarding product use and function, in addition to manufacturer liability and restrictions pertaining to it. The entire manual should be read carefully.

# General Description of the Equipment and Classification, SG-System I – Safety Instructions

The SG-SYSTEM I equipment is a CLASS 1, DESK-TOP (MOVABLE) OR RACK-MOUNTED (FIXED – STATIONARY), EQUIPMENT, PLUG-GABLE TYPE A using a DETACHABLE POWER SUPPLY CORD; it is designed to be INSTALLED, OPERATED and MAINTAINED by SERVICE PERSONS ONLY. [person having appropriate technical training and experience necessary to be aware of hazards to which that person may be exposed in performing a task and of measures to minimize the risks to that person or other persons]. The equipment SG-SYSTEM I shall be installed in RESTRICTED ACCESS LOCATIONS within an environment that provides the Pollution Degree max 2, and over-voltages category II – non-hazardous locations, indoor only.

The POWER SUPPLY CORD serves as a means of disconnection from the MAINS. The OUTLET used to power the equipment shall be installed near the equipment, and shall be easily accessible. The equipment must be connected to a socket outlet with a protective grounding electrode conductor! WHEN RACK-MOUNTED, IT IS THE RESPONSIBILITY OF THE INSTALLER TO ENSURE THAT THE FINAL ASSEMBLY that includes SG-System I EQUIPMENT IS COMPLIANT with the applicable requirements from the point of view of STABILITY; the rack-mounted equipment must be secured to the building structure before operation; all wiring and installation shall be in accordance with electrical codes acceptable to the authorities that have jurisdiction where the equipment is installed, serviced and operated; not more than 3 (three) SG-System I units mounted within the same rack shall be powered from the same branch circuit; use a different branch circuit for any group larger than 3 (three) units.

Inter-connecting cables shall be routed in a manner that prevents excessive strain on wire and on terminal connections; loosening of terminal connections; damage of conductor insulation. This product used Lithium Batteries. Improper handling of lithium batteries may result in heat generation, explosion or fire, which may lead to personal injury.

## CONNECTION TO THE MAINS:

Connect the DETACHABLE POWER SUPPLY CORD to the IEC 320 connector located on SG-System I equipment.

CAUTION: The Ethernet communication lines must be connected first to an Approved (acceptable to the local authorities) type NID (Network Interface Device) before leaving the premises (e.g. UL Installations, UL60950 Listed NID for ULC Installations CAN/CSA C22.2 No. 60950-1 Listed NID).

NO REPAIRS IN THE FIELD ARE ALLOWED. THE EQUIPMENT SG-System I MUST BE RETURNED TO THE MANUFACTURER FOR REPAIRS.

## Safety Considerations

The unit is to be installed and used in an environment that provides pollution degree max 2 and overvoltages category II, indoors, in a non-hazardous location only. The SG-System I is intended to be installed, operated, and maintained by Service Persons only, in restricted access locations. The equipment is included within a metallic enclosure that fulfills all of the applicable requirements for a fire enclosure. The enclosure cannot be opened without the use of a tool.

When installing, connecting, or operating the SG-System I, take care to observe the following precautions:

- Connect the connection cable to the appropriate socket.
- Ensure that the cables are laid out in such a way that accidents cannot occur. Connected cables must not be subject to excessive mechanical strain.
- Use only authorised accessories with this equipment.
- Protect the receiver from moisture, dust, liquids, and vapors.

## Important Safety Guidelines

1. Never install telephone wiring during an electrical storm.
2. Read these instructions and save for later reference.
3. Follow all warnings and instructions as marked on the product.
4. Unplug the receiver from the mains power and telephone line sockets prior to cleaning. Use only a soft, damp cloth to clean the device. Do not use abrasive liquids or chemicals to clean the device.
5. Do not place this product on an unstable cart, stand, or table. The receiver may fall, causing serious damage to the product and the operator.
6. Unplug the receiver from the mains power and telephone line sockets and refer servicing to qualified service personnel under the following conditions:
  - When the mains power cord is frayed, or the plug is damaged.
  - If liquid has been spilled into the receiver, or exposed to rain or water.
  - If the receiver does not operate normally when the operating instructions are followed.
  - If the receiver exhibits a distinct reduction in performance

## FCC COMPLIANCE STATEMENT

**CAUTION:** Changes or modifications not expressly approved by Digital Security Controls could void your authority to use this equipment. This equipment has been tested and found to comply with the limits for a Class B digital device, pursuant to Part 15 of the FCC Rules. These limits are designed to provide reasonable protection against harmful interference in a residential installation. This equipment generates, uses and can radiate radio frequency energy and, if not installed and used in accordance with the instructions, may cause harmful interference to radio communications. However, there is no guarantee that interference will not occur in a particular installation. If this equipment does cause harmful interference to radio or television reception, which can be determined by turning the equipment off and on, the user is encouraged to try to correct the interference by one or more of the following measures:

- Re-orient the receiving antenna.
- Increase the separation between the equipment and receiver.
- Connect the equipment into an outlet on a circuit different from that to which the receiver is connected.
- Consult the dealer or an experienced radio/television technician for help.

The user may find the following booklet prepared by the FCC useful: "How to Identify and Resolve Radio/Television Interference Problems". This booklet is available from the U.S. Government Printing Office, Washington D.C. 20402, Stock # 004-000-00345-4.

### **IMPORTANT INFORMATION**

This equipment complies with Part 68 of the FCC Rules and the requirements adopted by the ACTA. On the side of this equipment is a label that contains, among other information, a product identifier in the format US:AAAEQ##TXXXX. If requested, this number must be provided to the Telephone Company.

Product identifier: US:F53AL01BSYSTEM1

USOC Jack: RJ-11

### **Telephone Connection Requirements**

A plug and jack used to connect this equipment to the premises wiring and telephone network must comply with the applicable FCC Part 68 rules and requirements adopted by the ACTA. A compliant telephone cord and modular plug is provided with this product. It is designed to be connected to a compatible modular jack that is also compliant. See installation instructions for details.

### **Ringer Equivalence Number (REN)**

The REN is used to determine the number of devices that may be connected to a telephone line. Excessive RENs on a telephone line may result in the devices not ringing in response to an incoming call. In most but not all areas, the sum of RENs should not exceed five (5.0). To be certain of the number of devices that may be connected to a line, as determined by the total RENs, contact the local Telephone Company. For products approved after July 23, 2001, the REN for this product is part of the product identifier that has the format US: AAAEQ##TXXXX. The digits represented by ## are the REN without a decimal point (e.g., 03 is a REN of 0.3). For earlier products, the REN is separately shown on the label.

### **Incidence of Harm**

If this equipment SG-SYSTEM I causes harm to the telephone network, the telephone company will notify you in advance that temporary discontinuance of service may be required. But if advance notice is not practical, the Telephone Company will notify the customer as soon as possible. Also, you will be advised of your right to file a complaint with the FCC if you believe it is necessary.

### **Changes in Telephone Company Equipment or Facilities**

The Telephone Company may make changes in its facilities, equipment, operations or procedures that could affect the operation of the equipment. If this happens the Telephone Company will provide advance notice in order for you to make necessary modifications to maintain uninterrupted service.

### **Equipment Maintenance Facility**

If trouble is experienced with this equipment SG-SYSTEM I for repair or warranty information, please contact the facility indicated below. If the equipment is causing harm to the telephone network, the Telephone Company may request that you disconnect the equipment until the problem is solved. This equipment is of a type that is not intended to be repaired by the end user.

DSC c/o APL Logistics 757 Douglas Hill Rd, Lithia Springs, GA 30122

### **Additional Information**

Connection to party line service is subject to state tariffs. Contact the state public utility commission, public service commission or corporation commission for information.

Alarm dialing equipment must be able to seize the telephone line and place a call in an emergency situation. It must be able to do this even if other equipment (telephone, answering system, computer modem, etc.) already has the telephone line in use. To do so, alarm dialing equipment must be connected to a properly installed RJ-31X jack that is electrically in series with and ahead of all other equipment attached to the same telephone line. Proper

installation is depicted in the figure below. If you have any questions concerning these instructions, you should consult your telephone company or a qualified installer about installing the RJ-31X jack and alarm dialling equipment for you.

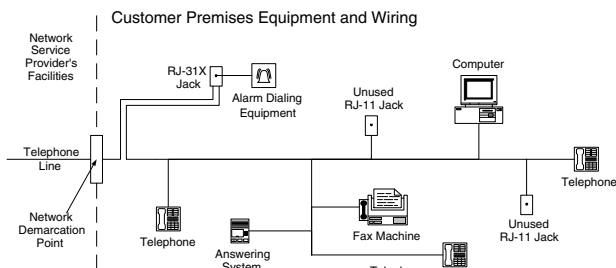

## Industry Canada Statement

IC: 160A-SYSTEM1

NOTICE: This equipment meets the applicable Industry Canada terminal Equipment Technical Specifications. This is confirmed by the registration number. The abbreviation, IC, before the registration number signifies that registration was performed based on a Declaration of Conformity indicating that Industry Canada technical specifications were met. It does not imply that Industry Canada approved the equipment.

L'étiquette de l'Industrie Canada identifie le matériel homologué. Cette étiquette certifie que le matériel est conforme à certaines normes de protection, d'exploitation et de sécurité des réseaux de télécommunications. Industrie Canada n'assure toutefois pas que le matériel fonctionnera à la satisfaction de l'utilisateur. Le présent matériel est conforme aux spécifications techniques applicables d'Industrie Canada.

NOTICE: The Ringer Equivalence Number (REN) for this terminal is 01. The REN assigned to each terminal equipment provides an indication of the maximum number of terminals allowed to be connected to a telephone interface. The termination on an interface may consist of any combination of devices subject only to the requirement that the sum of the Ringer Equivalence Numbers of all the devices does not exceed five. This Class B digital apparatus complies with Canadian ICES-003.

L'indice d'équivalence de la sonnerie (IES) sert à indiquer le nombre maximal de terminaux qui peuvent être raccordés à une interface téléphonique. La terminaison d'une interface peut consister en une combinaison quelconque de dispositifs, à la seule condition que la somme d'indices d'équivalence de la sonnerie de tous les dispositifs n'excède pas 5. Cet appareil numérique de la classe B est conforme à la norme NMB-003 du Canada.

## Limited Warranty

Digital Security Controls warrants the original purchaser that for a period of twelve months from the date of purchase, the product shall be free of defects in materials and workmanship under normal use. During the warranty period, Digital Security Controls shall, at its option, repair or replace any defective product upon return of the product to its factory, at no charge for labour and materials. Any replacement and/or repaired parts are warranted for the remainder of the original warranty or ninety (90) days, whichever is longer. The original purchaser must promptly notify Digital Security Controls in writing that there is defect in material or workmanship, such written notice to be received in all events prior to expiration of the warranty period. There is absolutely no warranty on software and all software products are sold as a user license under the terms of the software license agreement included with the product. The Customer assumes all responsibility for the proper selection, installation, operation and maintenance of any products purchased from DSC. Custom products are only warranted to the extent that they do not function upon delivery. In such cases, DSC can replace or credit at its option.

### International Warranty

The warranty for international customers is the same as for any customer within Canada and the United States, with the exception that Digital Security Controls shall not be responsible for any customs fees, taxes, or VAT that may be due.

### Warranty Procedure

To obtain service under this warranty, please return the item(s) in question to the point of purchase. All authorized distributors and dealers have a warranty program. Anyone returning goods to Digital Security Controls must first obtain an authorization number. Digital Security Controls will not accept any shipment whatsoever for which prior authorization has not been obtained.

#### Conditions to Void Warranty

This warranty applies only to defects in parts and workmanship relating to normal use. It does not cover:

- damage incurred in shipping or handling;
- damage caused by disaster such as fire, flood, wind, earthquake or lightning;
- damage due to causes beyond the control of Digital Security Controls such as excessive voltage, mechanical shock or water damage;
- damage caused by unauthorized attachment, alterations, modifications or foreign objects;
- damage caused by peripherals (unless such peripherals were supplied by Digital Security Controls);
- defects caused by failure to provide a suitable installation environment for the products;
- damage caused by use of the products for purposes other than those for which it was designed;
- damage from improper maintenance;
- damage arising out of any other abuse, mishandling or improper application of the products.

#### Items Not Covered by Warranty

In addition to the items which void the Warranty, the following items shall not be covered by Warranty: (i) freight cost to the repair centre; (ii) products which are not identified with DSC's product label and lot number or serial number; (iii) products disassembled or repaired in such a manner as to adversely affect performance or prevent adequate inspection or testing to verify any warranty claim. Access cards or tags returned for replacement under warranty will be credited or replaced at DSC's option. Products not covered by this warranty, or otherwise out of warranty due to age, misuse, or damage shall be evaluated, and a repair estimate shall be provided. No repair work will be performed until a valid purchase order is received from the Customer and a Return Merchandise Authorisation number (RMA) is issued by DSC's Customer Service.

Digital Security Controls' liability for failure to repair the product under this warranty after a reasonable number of attempts will be limited to a replacement of the product, as the exclusive remedy for breach of warranty. Under no circumstances shall Digital Security Controls be liable for any special, incidental, or consequential damages based upon breach of warranty, breach of contract, negligence, strict liability, or any other legal theory. Such damages include, but are not limited to, loss of profits, loss of the product or any associated equipment, cost of capital, cost of substitute or replacement equipment, facilities or services, down time, purchaser's time, the claims of third parties, including customers, and injury to property. The laws of some jurisdictions limit or do not allow the disclaimer of consequential damages. If the laws of such a jurisdiction apply to any claim by or against DSC, the limitations and disclaimers contained here shall be to the greatest extent permitted by law. Some states do not allow the exclusion or limitation of incidental or consequential damages, so that the above may not apply to you.

#### Disclaimer of Warranties

This warranty contains the entire warranty and shall be in lieu of any and all other warranties, whether expressed or implied (including all implied warranties of merchantability or fitness for a particular purpose) and of all other obligations or liabilities on the part of Digital Security Controls. Digital Security Controls neither assumes responsibility for, nor authorizes any other person purporting to act on its behalf to modify or to change this warranty, nor to assume for it any other warranty or liability concerning this product. This disclaimer of warranties and limited warranty are governed by the laws of the province of Ontario, Canada.

**WARNING: Digital Security Controls recommends that the entire system be completely tested on a regular basis. However, despite frequent testing, and due to, but not limited to, criminal tampering or electrical disruption, it is possible for this product to fail to perform as expected.**

#### Out of Warranty Repairs

Digital Security Controls will at its option repair or replace out-of-warranty products which are returned to its factory according to the following conditions. Anyone returning goods to Digital Security Controls must first obtain an authorization number. Digital Security Controls will not accept any shipment whatsoever for which prior authorization has not been obtained.

Products which Digital Security Controls determines to be repairable will be repaired and returned. A set fee which Digital Security Controls has pre-determined and which may be revised from time to time, will be charged for each unit repaired.

Products which Digital Security Controls determines not to be repairable will be replaced by the nearest equivalent product available at that time. The current market price of the replacement product will be charged for each replacement unit.

## **WARNING Please Read Carefully**

### *Note to Installers*

This warning contains vital information. As the only individual in contact with system users, it is your responsibility to bring each item in this warning to the attention of the users of this system.

### **System Failures**

This system has been carefully designed to be as effective as possible. There are circumstances, however, involving fire, burglary, or other types of emergencies where it may not provide protection. Any alarm system of any type may be compromised deliberately or may fail to operate as expected for a variety of reasons. Some but not all of these reasons may be:

#### **Inadequate Installation**

A security system must be installed properly in order to provide adequate protection. Every installation should be evaluated by a security professional to ensure that all access points and areas are covered. Locks and latches on windows and doors must be secure and operate as intended. Windows, doors, walls, ceilings and other building materials must be of sufficient strength and construction to provide the level of protection expected. A reevaluation must be done during and after any construction activity. An evaluation by the fire and/or police department is highly recommended if this service is available.

#### **Criminal Knowledge**

This system contains security features which were known to be effective at the time of manufacture. It is possible for persons with criminal intent to develop techniques which reduce the effectiveness of these features. It is important that a security system be reviewed periodically to ensure that its features remain effective and that it be updated or replaced if it is found that it does not provide the protection expected.

#### **Access by Intruders**

Intruders may enter through an unprotected access point, circumvent a sensing device, evade detection by moving through an area of insufficient coverage, disconnect a warning device, or interfere with or prevent the proper operation of the system.

#### **Power Failure**

Control units, intrusion detectors, smoke detectors and many other security devices require an adequate power supply for proper operation. If a device operates from batteries, it is possible for the batteries to fail. Even if the batteries have not failed, they must be charged, in good condition and installed correctly. If a device operates only by AC power, any interruption, however brief, will render that device inoperative while it does not have power. Power interruptions of any length are often accompanied by voltage fluctuations which may damage electronic equipment such as a security system. After a power interruption has occurred, immediately conduct a complete system test to ensure that the system operates as intended.

#### **Failure of Replaceable Batteries**

This system's wireless transmitters have been designed to provide several years of battery life under normal conditions. The expected battery life is a function of the device environment, usage and type. Ambient conditions such as high humidity, high or low temperatures, or large temperature fluctuations may reduce the expected battery life. While each transmitting device has a low battery monitor which identifies when the batteries need to be replaced, this monitor may fail to operate as expected. Regular testing and maintenance will keep the system in good operating condition.

#### **Compromise of Radio Frequency (Wireless) Devices**

Signals may not reach the receiver under all circumstances which could include metal objects placed on or near the radio path or deliberate jamming or other inadvertent radio signal interference.

#### **System Users**

A user may not be able to operate a panic or emergency switch possibly due to permanent or temporary physical disability, inability to reach the device in time, or unfamiliarity with the correct operation. It is important that all system users be trained in the correct operation of the alarm system and that they know how to respond when the system indicates an alarm.

#### **Smoke Detectors**

Smoke detectors that are a part of this system may not properly alert occupants of a fire for a number of reasons, some of which follow. The smoke detectors may have been improperly installed or positioned. Smoke may not be able to reach the smoke detectors, such as when the fire is in a chimney, walls or roofs, or on the other side of closed doors. Smoke detectors may not detect smoke from fires on another level of the residence or building. Every fire is different in the amount of smoke produced and the rate of burning. Smoke detectors cannot sense all types of fires equally well. Smoke detectors may not provide timely warning of fires caused by carelessness or safety hazards such as smoking in bed, violent explosions, escaping gas, improper storage of flammable materials, overloaded electrical circuits, children playing with matches or arson.

Even if the smoke detector operates as intended, there may be circumstances when there is insufficient warning to allow all occupants to escape in time to avoid injury or death.

#### **Motion Detectors**

Motion detectors can only detect motion within the designated areas as shown in their respective installation instructions. They cannot discriminate between intruders and intended occupants. Motion detectors do not provide volumetric area protection. They have multiple beams of detection and motion can only be detected in unobstructed areas covered by these beams. They cannot detect motion which occurs behind walls, ceilings, floor, closed doors, glass partitions, glass doors or windows. Any type of tampering whether intentional or unintentional such as masking, painting, or spraying of any material on the lenses, mirrors, windows or any other part of the detection system will impair its proper operation.

Passive infrared motion detectors operate by sensing changes in temperature. However their effectiveness can be reduced when the ambient temperature rises near or above body temperature or if there are intentional or unintentional sources of heat in or near the detection area. Some of these heat sources could be heaters, radiators, stoves, barbecues, fireplaces, sunlight, steam vents, lighting and so on.

### **Warning Devices**

Warning devices such as sirens, bells, horns, or strobes may not warn people or waken someone sleeping if there is an intervening wall or door. If warning devices are located on a different level of the residence or premise, then it is less likely that the occupants will be alerted or awakened. Audible warning devices may be interfered with by other noise sources such as stereos, radios, televisions, air conditioners or other appliances, or passing traffic. Audible warning devices, however loud, may not be heard by a hearing-impaired person.

### **Telephone Lines**

If telephone lines are used to transmit alarms, they may be out of service or busy for certain periods of time. Also an intruder may cut the telephone line or defeat its operation by more sophisticated means which may be difficult to detect.

### **Insufficient Time**

There may be circumstances when the system will operate as intended, yet the occupants will not be protected from the emergency due to their inability to respond to the warnings in a timely manner. If the system is monitored, the response may not occur in time to protect the occupants or their belongings.

### **Component Failure**

Although every effort has been made to make this system as reliable as possible, the system may fail to function as intended due to the failure of a component.

### **Inadequate Testing**

Most problems that would prevent an alarm system from operating as intended can be found by regular testing and maintenance. The complete system should be tested weekly and immediately after a break-in, an attempted break-in, a fire, a storm, an earthquake, an accident, or any kind of construction activity inside or outside the premises. The testing should include all sensing devices, keypads, consoles, alarm indicating devices and any other operational devices that are part of the system.

### **Security and Insurance**

Regardless of its capabilities, an alarm system is not a substitute for property or life insurance. An alarm system also is not a substitute for property owners, renters, or other occupants to act prudently to prevent or minimize the harmful effects of an emergency situation.

## **IMPORTANT - READ CAREFULLY:**

DSC Software purchased with or without Products and Components is copyrighted and is purchased under the following license terms:

This End-User License Agreement ("EULA") is a legal agreement between You (the company, individual or entity who acquired the Software and any related Hardware) and Digital Security Controls, a division of Tyco Safety Products Canada Ltd. ("DSC"), the manufacturer of the integrated security systems and the developer of the software and any related products or components ("HARDWARE") which You acquired.

If the DSC software product ("SOFTWARE PRODUCT" or "SOFTWARE") is intended to be accompanied by HARDWARE, and is NOT accompanied by new HARDWARE, You may not use, copy or install the SOFTWARE PRODUCT. The SOFTWARE PRODUCT includes computer software, and may include associated media, printed materials, and "online" or electronic documentation.

Any software provided along with the SOFTWARE PRODUCT that is associated with a separate end-user license agreement is licensed to You under the terms of that license agreement.

By installing, copying, downloading, storing, accessing or otherwise using the SOFTWARE PRODUCT, You agree unconditionally to be bound by the terms of this EULA, even if this EULA is deemed to be a modification of any previous arrangement or contract. If You do not agree to the terms of this EULA, DSC is unwilling to license the SOFTWARE PRODUCT to You, and You have no right to use it.

### **SOFTWARE PRODUCT LICENSE**

The SOFTWARE PRODUCT is protected by copyright laws and international copyright treaties, as well as other intellectual property laws and treaties. The SOFTWARE PRODUCT is licensed, not sold.

#### **1. GRANT OF LICENSE.**

This EULA grants You the following rights:

(a) *Software Installation and Use* - For each license You acquire, You may have only one copy of the SOFTWARE PRODUCT installed.

(b) *Storage/Network Use* - The SOFTWARE PRODUCT may not be installed, accessed, displayed, run, shared or used concurrently on or from different computers, including a workstation, terminal or other digital electronic device ("Device"). In other words, if You have several workstations, You will have to acquire a license for each workstation where the SOFTWARE will be used.

(c) *Backup Copy* - You may make back-up copies of the SOFTWARE PRODUCT, but You may only have one copy per license installed at any given time. You may use the back-up copy solely for archival purposes. Except as expressly provided in this EULA, You may not otherwise make copies of the SOFTWARE PRODUCT, including the printed materials accompanying the SOFTWARE.

#### **2. DESCRIPTION OF OTHER RIGHTS AND LIMITATIONS.**

(a) *Limitations on Reverse Engineering, Decompilation and Disassembly* - You may not reverse engineer, decompile, or disassemble the SOFTWARE PRODUCT, except and only to the extent that such activity is expressly permitted by applicable law notwithstanding this limitation. You may not

make any changes or modifications to the Software, without the written permission of an officer of DSC. You may not remove any proprietary notices, marks or labels from the Software Product. You shall institute reasonable measures to ensure compliance with the terms and conditions of this EULA.

*(b) Separation of Components* - The SOFTWARE PRODUCT is licensed as a single product. Its component parts may not be separated for use on more than one HARDWARE unit.

*(c) Single INTEGRATED PRODUCT* - If You acquired this SOFTWARE with HARDWARE, then the SOFTWARE PRODUCT is licensed with the HARDWARE as a single integrated product. In this case, the SOFTWARE PRODUCT may only be used with the HARDWARE as set forth in this EULA.

*(d) Rental* - You may not rent, lease or lend the SOFTWARE PRODUCT. You may not make it available to others or post it on a server or web site.

*(e) Software Product Transfer* - You may transfer all of Your rights under this EULA only as part of a permanent sale or transfer of the HARDWARE, provided You retain no copies, You transfer all of the SOFTWARE PRODUCT (including all component parts, the media and printed materials, any upgrades and this EULA), and provided the recipient agrees to the terms of this EULA. If the SOFTWARE PRODUCT is an upgrade, any transfer must also include all prior versions of the SOFTWARE PRODUCT.

*(f) Termination* - Without prejudice to any other rights, DSC may terminate this EULA if You fail to comply with the terms and conditions of this EULA. In such event, You must destroy all copies of the SOFTWARE PRODUCT and all of its component parts.

*(g) Trademarks* - This EULA does not grant You any rights in connection with any trademarks or service marks of DSC or its suppliers.

### **3. COPYRIGHT.**

All title and intellectual property rights in and to the SOFTWARE PRODUCT (including but not limited to any images, photographs, and text incorporated into the SOFTWARE PRODUCT), the accompanying printed materials, and any copies of the SOFTWARE PRODUCT, are owned by DSC or its suppliers. You may not copy the printed materials accompanying the SOFTWARE PRODUCT. All title and intellectual property rights in and to the content which may be accessed through use of the SOFTWARE PRODUCT are the property of the respective content owner and may be protected by applicable copyright or other intellectual property laws and treaties. This EULA grants You no rights to use such content. All rights not expressly granted under this EULA are reserved by DSC and its suppliers.

### **4. EXPORT RESTRICTIONS.**

You agree that You will not export or re-export the SOFTWARE PRODUCT to any country, person, or entity subject to Canadian export restrictions.

### **5. CHOICE OF LAW:**

This Software License Agreement is governed by the laws of the Province of Ontario, Canada.

### **6. ARBITRATION**

All disputes arising in connection with this Agreement shall be determined by final and binding arbitration in accordance with the Arbitration Act, and the parties agree to be bound by the arbitrator's decision. The place of arbitration shall be Toronto, Canada, and the language of the arbitration shall be English.

### **7. LIMITED WARRANTY**

#### *(i) NO WARRANTY*

DSC PROVIDES THE SOFTWARE "AS IS" WITHOUT WARRANTY. DSC DOES NOT WARRANT THAT THE SOFTWARE WILL MEET YOUR REQUIREMENTS OR THAT OPERATION OF THE SOFTWARE WILL BE UNINTERRUPTED OR ERROR-FREE.

#### *(j) CHANGES IN OPERATING ENVIRONMENT*

DSC shall not be responsible for problems caused by changes in the operating characteristics of the HARDWARE, or for problems in the interaction of the SOFTWARE PRODUCT with non-DSC-SOFTWARE or HARDWARE PRODUCTS.

#### *(k) LIMITATION OF LIABILITY; WARRANTY REFLECTS ALLOCATION OF RISK*

IN ANY EVENT, IF ANY STATUTE IMPLIES WARRANTIES OR CONDITIONS NOT STATED IN THIS LICENSE AGREEMENT, DSC'S ENTIRE LIABILITY UNDER ANY PROVISION OF THIS LICENSE AGREEMENT SHALL BE LIMITED TO THE GREATER OF THE AMOUNT ACTUALLY PAID BY YOU TO LICENSE THE SOFTWARE PRODUCT AND FIVE CANADIAN DOLLARS (CAD\$5.00). BECAUSE SOME JURISDICTIONS DO NOT ALLOW THE EXCLUSION OR LIMITATION OF LIABILITY FOR CONSEQUENTIAL OR INCIDENTAL DAMAGES, THE ABOVE LIMITATION MAY NOT APPLY TO YOU.

#### *(l) DISCLAIMER OF WARRANTIES*

THIS WARRANTY CONTAINS THE ENTIRE WARRANTY AND SHALL BE IN LIEU OF ANY AND ALL OTHER WARRANTIES, WHETHER EXPRESSED OR IMPLIED (INCLUDING ALL IMPLIED WARRANTIES OF MERCHANTABILITY OR FITNESS FOR A PARTICULAR PURPOSE) AND OF ALL OTHER OBLIGATIONS OR LIABILITIES ON THE PART OF DSC. DSC MAKES NO OTHER WARRANTIES. DSC NEITHER ASSUMES NOR AUTHORIZES ANY OTHER PERSON PURPORTING TO ACT ON ITS BEHALF TO MODIFY OR TO CHANGE THIS WARRANTY, NOR TO ASSUME FOR IT ANY OTHER WARRANTY OR LIABILITY CONCERNING THIS SOFTWARE PRODUCT.

#### *(m) EXCLUSIVE REMEDY AND LIMITATION OF WARRANTY*

UNDER NO CIRCUMSTANCES SHALL DSC BE LIABLE FOR ANY SPECIAL, INCIDENTAL, CONSEQUENTIAL OR INDIRECT DAMAGES BASED UPON BREACH OF WARRANTY, BREACH OF CONTRACT, NEGLIGENCE, STRICT LIABILITY, OR ANY OTHER LEGAL THEORY. SUCH DAMAGES INCLUDE, BUT ARE NOT LIMITED TO, LOSS OF PROFITS, LOSS OF THE SOFTWARE PRODUCT OR ANY



ASSOCIATED EQUIPMENT, COST OF CAPITAL, COST OF SUBSTITUTE OR REPLACEMENT EQUIPMENT, FACILITIES OR SERVICES, DOWN TIME, PURCHASERS TIME, THE CLAIMS OF THIRD PARTIES, INCLUDING CUSTOMERS, AND INJURY TO PROPERTY.  
WARNING: DSC recommends that the entire system be completely tested on a regular basis. However, despite frequent testing, and due to, but not limited to, criminal tampering or electrical disruption, it is possible for this SOFTWARE PRODUCT to fail to perform as expected.

# Table of Contents

<b>Chapter 1 - Introduction</b> .....	<b>8</b>
Features .....	9
Software Compatibility .....	9
Approvals .....	10
Industry Approvals .....	10
UL864 Programming Requirements .....	10
For UL and ULC listed applications the following UL/ULC listed printers can be used with the System I: .....	11
Specifications .....	12
Electrical .....	12
Environmental .....	12
Dimensions .....	12
Ethernet Interfaces .....	12
Accounts .....	12
Printers .....	12
Buffers .....	12
Out of Box .....	12
SG-System I .....	12
SG-System Rackmount Kit (Optional) - required for UL/ULC Listed Installations .....	13
Additional Equipment Required (Not Supplied) .....	13
<b>Chapter 2 - Installation</b> .....	<b>14</b>
Controls and Indicators .....	15
Set Up and Testing .....	18
The following items are required: .....	18
For UL/ULC Installations .....	19
For CE Installations .....	19
Warning: .....	19
<b>Chapter 3 - Operation</b> .....	<b>22</b>
Operation .....	23
Active Mode .....	23
Manual Mode .....	23
Program Category .....	24
Password .....	24
User Interface .....	24
Top Level Menu .....	25
View or Change Options .....	25
View Printer Buffer .....	25
System Functions .....	25
Exit Programming .....	25
System Functions Menu .....	25
System Information .....	25
Change Date and Time .....	26
Default SG-System I .....	26
Reset SG-System I .....	26
Visual Indicator Test .....	26
Exit Menu .....	26
Miscellaneous LED Indicators .....	26

View Trouble .....	26
Trouble List .....	27
View Network / Watchdog .....	27
View Status .....	27
<b>Chapter 4 - Options: System .....</b>	<b>28</b>
System Option Index .....	29
Steps required to access an option and change its setting or value .....	29
System Options .....	30
Option 001: LAN IP Address .....	30
Option 002: LAN Subnet Mask Address .....	30
Option 003: LAN Gateway .....	30
Option 004: Auto Update Time and Date .....	30
Option 005: Contrast .....	30
Option 006: Password .....	31
Option 007: Automation Baud Rate .....	31
Option 008: Automation Data Bits .....	31
Option 009: Automation Parity .....	32
Option 00A: Serial Printer Format .....	32
Option 00B: Serial Baud Rate .....	32
Option 00C: Serial Data Bits .....	32
Option 00D: Serial Printer Parity .....	33
Option 00E: AHS Operations Time .....	33
Option 00F: B32 Headers .....	33
Option 012: Heartbeat Timer .....	33
Option 013: Buzzer Tone .....	34
Option 014: Receiver Number .....	34
Option 015: Printer Test .....	34
Option 020: Mask UPS AC .....	35
Option 021: Mask UPS BAT .....	35
Option 024: Mask SG TCP/IP .....	35
Option 025: Mask SG Serial .....	35
Option 028: Mask TCP Printer .....	35
Option 029: Mask Parallel Printer .....	36
Option 02A: Mask Serial Printer .....	36
Option 02F: Automation Mode .....	36
Option 030: Printer Mode .....	37
Option 031: ACK Wait .....	38
Option 032: Date Format .....	39
Options 037 and 038: License Keys #1, #2 .....	39
Option 039: Mask USB Printer .....	39
Option 03A: Programmable I/O .....	39
Option 03B: Last Message On .....	40
Option 03C: LCD Backlight Colour .....	40
Option 03D: Key Backlight Colour .....	40
Option 040: Number of Channels .....	41
Option 041: System Number Length .....	41
Option 042: Busy Out .....	42
Option 043: System Protocol ID .....	42
Option 044: System CLASS Field .....	43
<b>Chapter 5 - Options: Channels 1 and 2 .....</b>	<b>44</b>
Channel Option Index .....	45
Steps required to access an option and change its setting or value .....	46

Static Options .....	46
Option 101: Line Card Number .....	46
Option 104: Two-Way Activation Time .....	46
Option 105: Pre-H.S. Duration .....	47
Option 109: First Ring Length .....	47
Option 10D: Ring Select.....	47
Option 10E: Backup Line Option .....	47
Option 111: Hook Flash Enable .....	48
Option 112: Caller Source ID .....	48
Option 113: Caller Source to SG Automation .....	49
Option 114: Caller Source to Printer .....	49
Option 117: DMP User Length .....	50
Option 118: DMP User Length .....	50
Option 119: Fault Call Counter .....	51
Option 11A: DNIS Input Sensitivity .....	51
Option 11F: Debug Option .....	52
Option 125: Phone Line Voltage Select .....	52
Option 127: Caller Source Process .....	52
Option 12A: Hook Flash Delay .....	52
Option 12C: Dialer Presence .....	53
Option 12D: AHS .....	53
Option 12F: Online Timeout .....	53
Dynamic Options .....	54
Options 130-13F: 3/1 - 4/1 Digit 0-F .....	54
Options 140-14F: 3/2 - 4/2 Digit 0-F .....	54
Options 150-15F: 4/3 Digit 0-F .....	54
Options 160-16F: Printer Words .....	55
Option 170: Automation Common Event Code.....	55
Option 171: Library Select .....	56
Option 172: SIA Option .....	57
Option 173: Input/Output Sensitivity .....	59
Option 174: Equivalent Line Number.....	59
Option 175: Receiver Number .....	59
Option 176: Accounts 3/x - 4/x .....	59
Option 177: Digit Replace .....	60
Option 178: Maximum Inter-Digit .....	60
Option 179: Maximum Inter-Burst .....	60
Option 17A: Four- and Five-Digit Account Codes To Activate Two-Way Radio .....	61
Option 17B: Three-Digit Account Codes To Activate Two-Way Radio .....	61
Option 17C: Audio Alarm Code Range .....	61
Option 17D: Audio Zone Code .....	62
Option 17E: Audio RS-232.....	62
Option 17F: Audio Format .....	62
Option 180: Kiss-off to Hang-up .....	63
Options 181 - 188: Handshake Selection .....	63
Options 189 - 190: Handshake and Kiss-off Duration .....	65
Option 191: Inter-Handshake Duration .....	66
Option 192: Pulse Mode .....	67
Option 193: Minimum Audio Tone .....	67
Option 194: Account Digit Stripping .....	67
Option 195: Five- and Six-Digit Pulse .....	69
Option 196: 4/1 Extended .....	70
Option 197: 4/2 Extended.....	70

Option 198: 3/1 Extended .....	70
Option 199: Ademco Express .....	71
Option 19A: Error Counter .....	71
Option 19B: Echo Cancellor .....	71
Option 19C: Acron RS-232 .....	71
Option 19D: Modem II RS-232 .....	72
Option 19E: Scantronics Select .....	72
Option 19F: Ademco High Speed RS-232 .....	72
Option 1A0: 11-/12-Digit DTMF (Acron, Scantronics, or Scancom 433) .....	73
Option 1A1: FBI RS-232 .....	74
Option 1A2: Digit Replace .....	74
Option 1A3: D6500 RS232 .....	74
Option 1A4: BFSK RS-232 .....	75
Option 1A5: SESCO Super Speed .....	76
Option 1A6: ITI Adjust .....	76
Option 1A7: Silent Knight FSK2 RS-232 .....	76
Option 1A8-1AF: Dial-Out Number for Two-Way Audio Transfer .....	77
Option 1B0: CCITT Audio Format Enable Bits .....	78
Option 1B1: DMP Area BIN or DEC Option .....	78
Option 1B2: Format Disable .....	79
<b>Chapter 6 - Options: IP .....</b>	<b>80</b>
IP Option Index .....	81
Steps required to access an option and change its setting or value .....	81
IP Options .....	1
Option 30D: Alarm Port Number .....	81
Option 30F: Receiver Number .....	82
Option 310: Line Card Number .....	82
Option 313: Transmitter Failure Debounce Time .....	82
Option 315: Transmitter Restoral Debounce Time .....	82
Option 319: Mask Transmitter Restoral .....	82
Option 31A: Mask Transmitter Failure .....	82
Option 31B: Mask Transmitter Swap .....	83
Option 31C: Mask Transmitter Unencrypted .....	83
Option 31D: Mask Invalid Report .....	83
Option 31E: Mask Unknown Account .....	83
Option 31F: Mask Supervised Acc Exceeded .....	84
Option 320: Mask Transmitter Deleted .....	84
Option 33A: Account Port .....	84
Option 340: Account Password .....	84
Option 344: DNIS Replacement of RRLLL .....	84
Option 346: Account Digit Strip .....	85
Option 347: SIM ID Output .....	85
<b>Appendix A - Events and Messages .....</b>	<b>88</b>
<b>Appendix B - Ports .....</b>	<b>94</b>
Parallel Printer Port .....	95
Serial Printer Port (COM2) .....	96
RS-232 Serial Automation .....	96
I/O Port .....	97
I/O Ports - Detailed Descriptions .....	97
<b>Appendix C - Compatible IP Formats .....</b>	<b>100</b>

Appendix D - Printer Words .....102  
Appendix E - Profiles .....106



# 1

# Introduction

---

## In This Chapter...

Features on page 9

Software Compatibility on page 9

Approvals on page 10

Specifications on page 12

Out of Box on page 12

## Features

The SG-System I is a dual phone line / IP network receiver intended for the remote monitoring of residential / commercial fire and burglary alarm systems. The system can be configured for desktop stand-alone operation (vertical stacking of up to 4 systems) or rack mounting (see Note below). The SG-System I can monitor up to 512 IP accounts. Please refer to **Table 4: Loading Capacities for Hunt Groups on page 18** for maximum capacities when communication over PSTN. The receiver can be connected to a USB port or Ethernet port on any computer running SG System Console software for system programming and printer messages. The receiver provides several connection options for Serial RS232 printers and Parallel printers.

The SG-System I is a pluggable equipment type A, using a detachable power supply cord.

The SG-System I real-time clock and calendar stamps receive alarm data which are transmitted to a central station computer via a TCP/IP connection and/or a Serial port using either a standard COM port and/or a USB port.

System configuration can be undertaken using a PC with SG-System I Console Software installed, or locally using the scroll buttons and the LCD on the front panel of the unit.

**NOTE: System must be rack mounted for UL and ULC Listed Installations.**

SG-System I features include the following:

- Dual Telco Interface
- Independent options list for each channel
- Remote alarm ACK button
- Caller ID
- SG-Systems Console Software (one software package for SG-System I, II receivers)
- Ability to call out to other receivers to check the communication path
- Ability to disable a telephone line
- Selectable buzzer output tones
- LCD and keymat can cycle through colours and fade colours in / out
- IP (FIBRO) communications with alarm panels and transmitters / Software-controlled features

*Figure 1: SG-System I Receiver*



## Software Compatibility

The following examples of Central Station automation software are compatible with the SG-System I interface:

<b>MAS</b>	<b>DICE</b>	<b>SIMS II</b>	<b>GENESYS</b>	<b>S.I.S.</b>
<b>IBS</b>	<b>MicroKey</b>	<b>ABM</b>	<b>Bold</b>	

Refer to the DSC website - <http://www.dsc.com/Default.aspx?id=79> - for a comprehensive list of compatible Automation Software Manufacturers.

**NOTE: Automation connections are considered supplementary as per UL864 listing. Compatibility with central station automation software is intended to be handled under a separate UL1981 software and/or site certification evaluation.**



## Approvals

### Industry Approvals

The System I meets the following standards:

- UL 1610 Central Station Burglar Alarm Units
- UL 864 Standard for Fire Alarm System Control Units and Accessories
- UL 1635 Digital Alarm Communicator System Units
- CAN/ULC-S304-06 Signal Receiving Centre and Premises Burglar Alarm Control Units
- CAN/ULC-S559-04 Equipment for Fire Signal Receiving Centres and Systems
- EN60950-1:2001 Standard for Information Technology Equipment
- AS/NZS 60950.1:2003 Information Technology Equipment - Safety, Part 1: General Requirements
- CISPR22 Class B Information Technology Equipment - Radio Disturbance Characteristics - Limits and Methods of Measurements
- EN50130-4 Immunity requirements for components of Fire, Intruder, and Social Alarm Systems.

This equipment shall be installed in the USA in accordance with the requirements of NFPA72, NFPA70, and the authority having jurisdiction.

In Canada, the equipment is ULC listed for active communication channel security levels A1~A4 when used in conjunction with T-Link TL250 and T-Link TL300 Internet/Intranet alarm communicators. For this type of application the supervision and encryption features have to be enabled. When used in conjunction with digital diallers, the receiver can provide passive communication channel security levels P1~P3.

For ULC Installations the equipment shall be installed in accordance with the requirements of ULC-S561, ULC-S301 and the authority having jurisdiction.

For installations in Japan, the power supply cord must be a PSE / JET Approved Type power cord with a female end type (IEC). It must meet

fully the DENAN Law Category A equipment and be marked with the diamond PSE logo



### UL864 Programming Requirements

**NOTE: To all Users, Installers, Authorities having Jurisdiction, and other involved parties. This product incorporates field programmable software. In order for the product to comply with the requirements in the Standard for Control Units and Accessories for Fire Alarms Systems, UL 864, certain programming features or options must be limited to specific values or not used at all, as indicated in the table below.**

**Table 1: UL864 Programming Requirements**

Option number and name	Permitted in UL 864? (Y/N)	Possible settings	Settings permitted (UL 864)	Settings permitted (ULC)
Option 013: Buzzer Tone	N	ON/OFF	ON	ON
Option 020: Mask UPS AC	N	ON/OFF	OFF	--
Option 021: Mask UPS BAT	N	ON/OFF	OFF	--
Option 024: Mask SG TCP/IP	N	ON/OFF	OFF	OFF
Option 025: Mask SG Serial	N	ON/OFF	OFF	OFF
Option 028: TCP Printer	N	ON/OFF	OFF	OFF
Option 029: Mask Parallel Printer	N	ON/OFF	OFF	OFF

**Table 1: UL864 Programming Requirements**

Option number and name	Permitted in UL 864? (Y/N)	Possible settings	Settings permitted (UL 864)	Settings permitted (ULC)
Option 02A: Mask Serial Printer	N	ON/OFF	OFF	OFF
Option 12C: Dialer Presence	Y	00/01/02	00/01/02	00
Option 12F: Online Timeout	Y	01-FF (1-255sec)	1E (30sec)	1E (30sec)
Option 039: Mask USB Printer	N	ON/OFF	OFF	OFF
Option 040: Number of Channels	Y	C1/C2/IP	C1+C2/ C1+C2+IP/C1+IP	C1+C2/ C1+C2+IP/C1+IP
Option 042: Busy Out	N	00/01/04/05	00	00
Option 105: Pre-H.S. Duration	Y	0A-FF (10-255sec)	0A (10sec)	0A (10sec)
Option 109: First Ring Length	Y	01-FF (1-255sec)	05 (5sec)-max	05 (5sec)-max
Option 181-188: Handshake Selection	Y	23/14/2D/0C/0E	2D/0C	Options 181-183: 2D/0C; Options 184-188 not used
Option 189, 190: Handshake and Kiss-off Duration	Y	100msec - 8.1sec	00 (1sec)	00 (1sec)
Option 191: Inter-Handshake Duration	Y	00-09 (1-9sec)	00-04 (1-4sec)	00-04 (1-4sec)
Option 313: Transmitter Failure Debounce Time	Y	1E-fd20 (30-64800sec)	05A (90sec)	05A (90sec)
Option 315: Transmitter Restoral Debounce Time	Y	1E-FF (30-255sec)	3C (60sec)	3C (60sec)
Option 319: Mask Transmitter Restoral	N	ON/OFF	OFF	OFF
Option 31A: Mask Transmitter Failure	N	ON/OFF	OFF	OFF
Option 31B: Mask Transmitter Swap	N	ON/OFF	OFF	OFF
Option 31C: Mask Transmitter Unencrypted	N	ON/OFF	OFF	OFF
Option 31D: Mask Invalid Report	N	ON/OFF	OFF	OFF
Option 31E: Mask Unknown Account	N	ON/OFF	OFF	OFF
Option 31F: Mask Supervised Acc Exceeded	N	ON/OFF	OFF	OFF

**For UL and ULC listed applications the following UL/ULC listed printers can be used with the System I:**

**Parallel Printers**

- Seiko DPU-414

**Serial Printers**

- Seiko DPU-414

**NOTE: Do not use printer cables that have only 1 common ground wire.**

## Specifications

**Table 2: SG-System I Specifications**

<b>Electrical</b>	
Input Voltage .....	100-240VAC, 50-60Hz.
Input Current .....	0.7A (Max)
Backup Power Supply External UPS .....	(not supplied)
Maximum Power Consumption .....	25 Watts
<b>Environmental</b>	
Temperature .....	0-49°C (32 - 120.2°F)
Humidity .....	93%RH, Non-Condensing
<b>Dimensions</b>	
Width .....	12in. (305mm)
Length .....	12.25in. (311mm)
Height .....	1.75in. (45mm)
Weight .....	7.92lbs (3.58 Kg)
<b>Ethernet Interfaces</b>	
Automation Port .....	1025
Printer Port .....	1027
Command Port (Console Interface) .....	1024
Debug Port .....	1030
TFTP Port .....	69
Account Port (Default) .....	3064
<b>Accounts</b>	
Supervised for Communication over PSDN .....	512 MAX
ULC Line Security Levels .....	A1-A4 (active channels) or P1-P3 (passive channels)
Refer to <b>Table 4: Loading Capacities for Hunt Groups on page 18</b> for loading capacities when using Communication over PSTN	
<b>Printers</b>	
Parallel .....	DMP-SCS-PTR, Seiko DPU-414
Serial .....	Seiko DPU-414
DACT Compatible communication formats (ULC passive channels) .....	SIA, CID
Encryption .....	AES 128 bit
<b>NOTE: Do not use printer cables that have only <u>one</u> common ground wire.</b>	
<b>Buffers</b>	
POTS .....	500 events
IP .....	512 events
System .....	50 events

## Out of Box

Verify that you have received the following:

### SG-System I

- SG-System I Receiver .....Qty 1
- SG-Systems Console Software CD ..... Qty 1
- SG-System I Quick Install Guide .....Qty 1

- Height-Adjustable Rubber Feet (front) .....Qty 2
- Rubber Feet (rear) .....Qty 2

**SG-System Rackmount Kit (Optional) - required for UL/ULC Listed Installations**

- Brackets .....Qty 2
- Rails (Mounting) .....Qty 4
- Screws .....Qty 8
- Quick Install Sheet .....Qty 1

**Additional Equipment Required (Not Supplied)**

- IEC Power Line Cord .....Qty 1
- CAT-5 Ethernet Cable for Network Interface Port or USB Cable for Console Communication .....Qty 1
- DB9 Terminated RS232 Serial Cable .....Qty 1
- DB25 Terminated Parallel Printer Cable .....Qty 1
- Phone Line Cable with RJ11 Jack (minimum 26 AWG) .....Qty 2



# 2

# Installation

---

In This Chapter...

Controls and Indicators on page 15

Set Up and Testing on page 18

## Controls and Indicators

Figure 2: Controls and Indicators

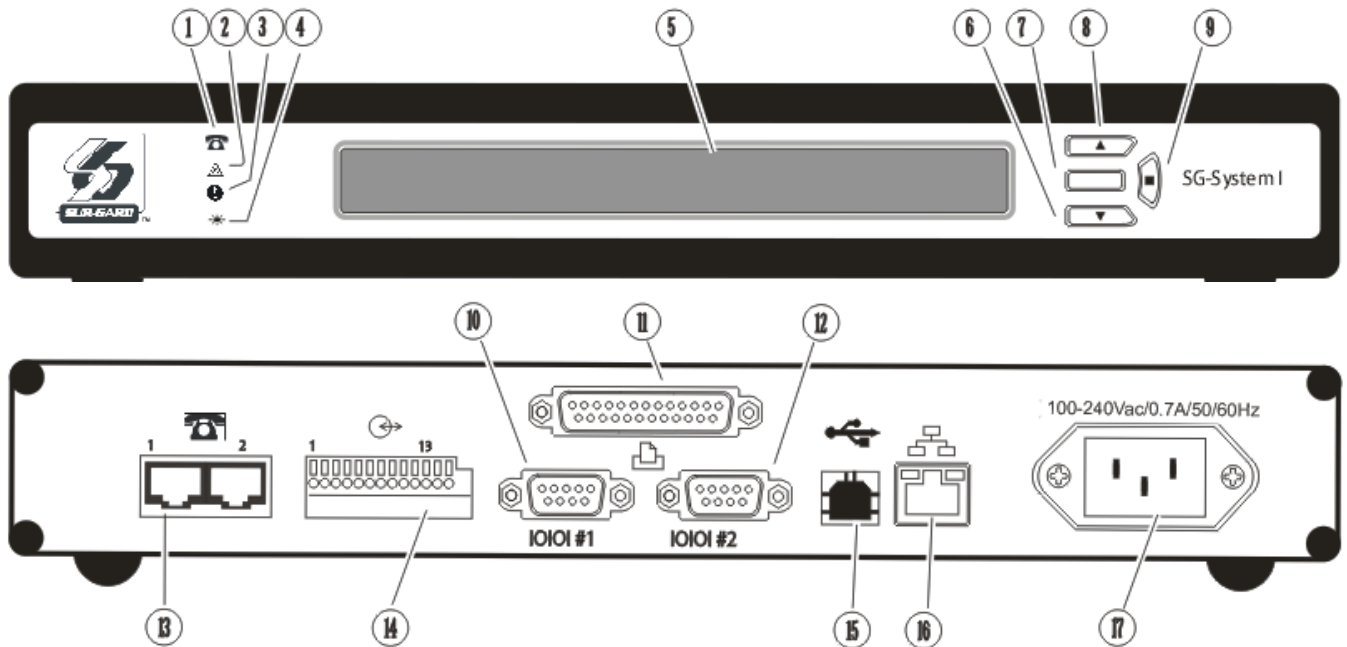





Table 3: SG-System I Front and Rear Panel Descriptions

Item no.	Indicator/ Control/ Connector	State/Pin	Description
1	TELEPHONE Red LED 	<b>OFF</b> <b>ON</b>	Both Telephone Lines are Present. At least One Telephone Line is Absent.
2	STATUS Orange LED 	<b>FLASHING</b>  <b>OFF</b>	Two Flashes indicates a Trouble as described below: <ul style="list-style-type: none"> <li>• Time Not Set</li> <li>• Computer Buffer Full</li> <li>• Printer Buffer Full</li> <li>• Software Corruption</li> <li>• Line Test Active</li> </ul> Normal Operation.
3	TROUBLE Yellow LED 	<b>ON</b> <b>OFF</b>	Indicates any System Trouble not related to network or alarm (Note that the LCD backlight will override the programmed colour and change to Yellow). No System Trouble.
4	WATCHDOG Blue LED 	<b>FLASHING</b> <b>STEADY</b>	Normal Operation (Software watchdog toggles every 200msec). SG-System I Fault.

**Table 3: SG-System I Front and Rear Panel Descriptions**

Item no.	Indicator/ Control/ Connector	State/Pin	Description
5	LCD Display		40x2 character LCD display. Top line displays current Operating Mode. Bottom line displays Trouble or received messages in Manual mode. Alarm: If an alarm is present while the system is in Manual mode, the LCD backlight will change to Red - overriding the programmed colour - and the ACK button will flash. In addition, a buzzer will sound with each flash of the ACK button. Alarms received but not yet displayed are identified by a solid arrow symbol on the far right edge of the LCD.
6	DOWN Interface Button		Scrolls down through menu options.
7	ACK Interface Button/ LED	<b>FLASHING OFF</b>	Indicates unit is in Manual Mode and waiting for acknowledgement. There are no alarm events requiring acknowledgement. The ACK button is used to acknowledge an alarm event in Manual Mode. It cannot acknowledge all alarms with one press, but must be pressed for each individual alarm.
8	UP Interface Button		Scrolls up through menu options.
9	ENTER Interface Button		Selects a menu option.
10	AUTOMATION Port (COM1)	DB9	Sends automation messages to central station computer (e.g. heartbeat if no activity). <b>NOTE: Maximum cable length is 1.8m (6ft). Longer cables may impair performance.</b>
11	PARALLEL PRINTER Port	DB25 (Female)	Sends events to local printer (DB25 Female). <b>NOTE: Maximum cable length is 1.8m (6ft). Longer cables may impair performance.</b>
12	SERIAL PRINTER Port (COM2)	DB9	RS232 Serial Printer Port. Sends events to local printer. <b>NOTE: Maximum cable length is 1.8m (6ft). Longer cables may impair performance.</b>
13	Telephone Line Input	2 x RJ-11	For connection with PSTN (alarm reporting connections using digital diallers-DACT). Pins 3 and 4 are line-in; pins 2 and 5 are backup channel line-in or two-way audio connection.

**Table 3: SG-System I Front and Rear Panel Descriptions**

Item no.	Indicator/ Control/ Connector	State/Pin	Description
14	I/O Port ( Use AWG 18-22 wire)	1 Input 2 ~ 3 Input 4 Input 5 ~ 6 Input 7 Output R1*  8 R1 9 Output R2 10 R2 11 Output R3  12 R3 13 ~	UPS AC Failure (toggles from ground to open on failure) Common (ground) UPS DC Failure (toggles from ground to open on failure) Remote ACK button - identical functionality to ACK button on LCD Common (ground) Future Use Follow Buzzer: relay contact closes following Buzzer output activations (synchronized) Relay Common Trouble Output: relay contact closes when the Trouble LED activates Relay Common Network Status: relay contact closes when the Network Status icon appears on the LCD Relay Common Earth (ground)  <b>NOTE: Maximum cable length is 1.8m (6ft). Longer cables may impair performance. The use of shielded cable is recommended.</b> <b>NOTE: Relays are rated for 12Vdc 100ma.</b> <b>NOTE: Inputs are rated for 20ma open collector.</b> *Rx is the relay number; as a rule, these outputs are open connections
15	USB Port	USB Type B	<b>USB Type B.</b> The USB port on SG System I is used to connect with a Windows host running the SG-Systems Console Software. Other operating systems are not supported.  <b>NOTE: Maximum cable length is 1.8m (6ft). Longer cables may impair performance.</b>
16	LAN Interface Port	CAT-5	This interface connects to the local network. Also, it is through this interface that a connection is made to the console software and the automation software.  <b>NOTE: Maximum cable length is 100m (328ft). Longer cables may impair performance.</b>
17	Mains Supply Connector		120/240VAC /0.7A/ 50-60Hz Connection to Interruptible Power Supply (UPS recommended) with minimum 24 hr. standby capability required. Refer to <b>Set Up and Testing on page 18.</b>

For ULC installations Canada, the equipment shall be rack-mounted and powered by a permanently wired supply in accordance with C22.1, Canadian Electrical Code, Part 1, Safety Standard for Electrical Installations, section 32. Please refer to **page 19**. This equipment is intended to utilize the building emergency AC supply system for their standby supply (e.g. UPS, batteries in conjunction with engine-driven generators).

**NOTE: The LED indicators and the LCD can be tested for integrity by accessing the following in the main programming menu: item 3 - System Functions > item 5 - Visual Indicators Test.**

**NOTE: For equipment used at Signal Receiving Centres and intended to facilitate IP communication (hubs, routers, NID, DSL/cable modems) 24hr backup power is required.**

**NOTE: When using Private, Corporate, and high-speed data networks, network access and domain access policies will be set to restrict unauthorised network access and 'spoofing' or 'denial of service' attacks. Select an ISP that provides redundant servers/systems, backup power, routers with firewalls enabled and methods to identify and protect against these types of attacks ('i.e. 'spoofing', 'dos').**



**NOTE: Firewall protection must be designed in such a way that the Automation software port connected to the SG-System I alarm receiver is protected from external attacks (e.g. 'spoofing', 'DOS').**

## Set Up and Testing

**NOTE: Install external devices connected to items (10)-(16) in the same room as the SG-System I. Maintain 6.5mm (1/4") of separation between power limited and non-power limited circuits. Use power limited, supervised circuits only.**

Familiarization with the connections and setup of the unit will make the final installation simpler. DSC recommends that the user gather all elements of the system and stage a successful trial run before going live.

### The following items are required:

- IEC power supply cord
- CAT5 Ethernet cable
- Phone line, dialer
- Hub/router or network

**NOTE: When a Hub or Router/Gateway is used with the SG-System I, 24 hr standby power is required for these devices (i.e. UL listed UPS, Battery Backup, or engine driven generator).**

### Take the following steps:

1. Unpack the SG-System I components. Remove the unit and inspect for shipping damage. If any damage is apparent, notify the carrier immediately.
2. Install the rack-mount brackets or the rubber feet in the indents as required.
3. Connect telephone.
4. Connect the main power using a standard computer IEC cable (not supplied). See the wiring diagram below.
5. The LCD will power up and display internal Troubles (printer, computer, telephone line fault).

**NOTE: Internal diagnostics may require more than 60 sec during the power up sequence.**

6. Send a signal from a control panel to the receiver using PSTN and PSDN communication protocols. The signal will be displayed on the LCD. Press the Ack button to silence the buzzer and clear the signal from the LCD.

Table 4: Loading Capacities for Hunt Groups

System loading at the supervising station	1 channel	2 channels	3 channels	4 channels	5-8 channels
Number of initiating circuits (with DACR lines processed in <i>parallel</i> )	~	5000	10 000	20 000	20 000
Number of DACTs (with DACR lines processed in <i>parallel</i> )	~	500	1500	3000	3000
Number of initiating circuits (with DACR lines processed <i>serially</i> - put on hold, then answered one at a time)	~	3000	5000	6000	6000
Number of DACTs (with DACR lines processed <i>serially</i> - put on hold, then answered one at a time)	~	300	800	1000	1000

**For UL/ULC Installations****Mains Supply:** 120VAC/60Hz

**UPS Output Rating:** 120VAC/60Hz, 2.5A. In the USA, use UL listed UPS (uninterrupted power supply) for protective-signalling systems and listed burglar alarm power supply as applicable. In Canada, connection to an emergency power supply (UPS) with a minimum of 24 hr standby capacity is required.

**For CE Installations****Mains Supply:** 240VAC/50Hz**UPS Output Rating (non UL):** 240VAC 50Hz**Warning:**

To reduce the risk of electrical shock, the SG-System I is equipped with a grounding-type power supply IEC receptacle. Connect SG-System I using an appropriate IEC cable to a grounded receptacle. Connect SG-System I to UPS dry contact connections only. Do not connect to a receptacle controlled by a switch.

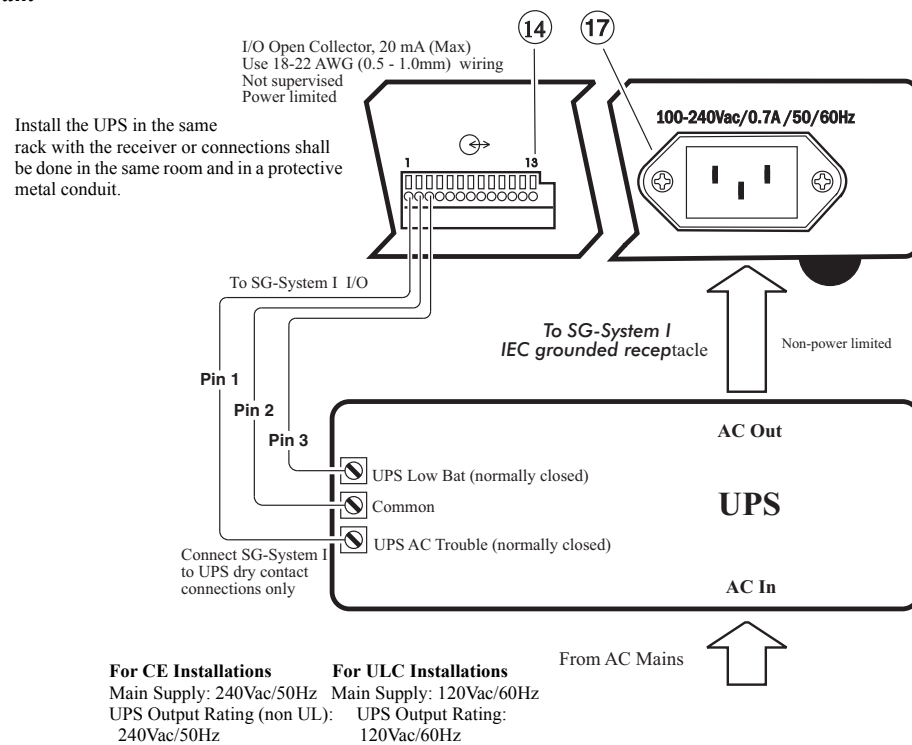
**Figure 3: Wiring Diagram**

**NOTE:** Install external devices connected to Items 10~17 in the same room as the SG-System I. Maintain a 6.5mm (1/4") separation between power limited and non-power limited circuits. All circuits are supervised and power limited with the exception of AC input, which is non-power limited. Maximum cable length is 1.8m (6'). Longer cables may impair performance.

**NOTE:** For ULC Installations, the equipment must be rack mounted and powered by a permanently wired supply in accordance with C22.1, Canadian Electrical Code, Part 1, Safety Standard for Electrical Installations, section 32. This equipment is intended to utilize the building emergency AC supply system for its standby supply (UPS, batteries in conjunction with engine-driven generator). Connection to Building Emergency Power Supply (UPS recommended) with a minimum 24hr standby capability is required. For UL Listed Installations, use UL Listed UPS (Uninterrupted Power Supply) for protective signalling systems and listed burglar alarm power supplies as applicable.

Figure 4: Wiring Diagram for Backup Channel and Two-Way Audio

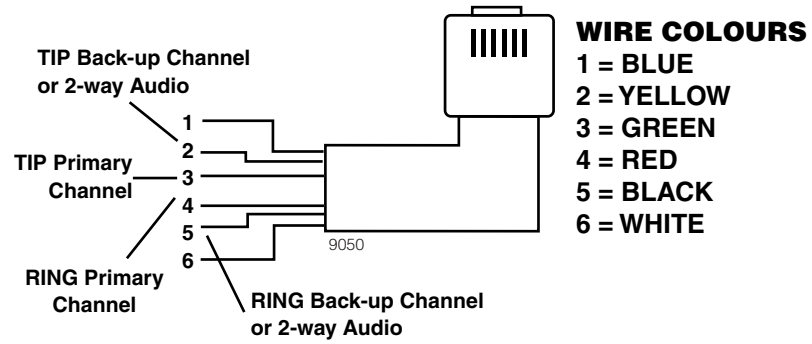





# 3 Operation

---

## In This Chapter...

Operation on page 23

Active Mode on page 23

Manual Mode on page 23

Program Category on page 24

Top Level Menu on page 25

System Functions Menu on page 25

Miscellaneous LED Indicators on page 26

## Operation

The SG-System I will occupy one of two states, **Operation** or **Program**. Operation consists of **Active** and **Manual** modes, in either of which the system will spend the vast majority of its working time. Program consists of the **Top Level Menu** and the **System Functions Menu**. The Top Level menu includes **View / Edit Options**, **View Printer**, **System Functions** and **Edit Programming**. While in System Functions you can access the **System Functions Menu**. This menu includes **System Information**, **Date and Time**, **Default SG-System I**, **Reset SG-System I**, **User Interface** and **Exit Menu**. See **Figure 5: Operating States(2), Modes(2), and Menus(2)** immediately below.

*Figure 5: Operating States(2), Modes(2), and Menus(2)*

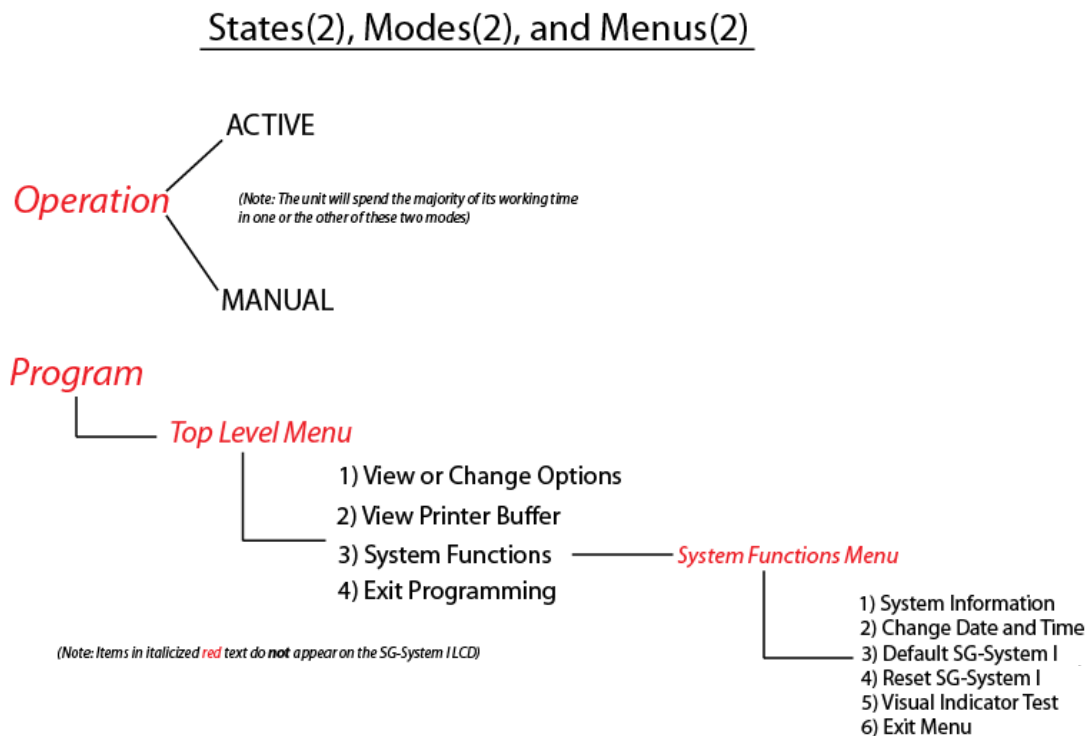

### Active Mode

Active mode is the most common operating mode. The SG-System I is in Active mode when any of the automation software ports are present and responding to signals. When there are no incoming calls to the unit, Active mode will give way to Manual mode. On receiving an incoming call, the unit will automatically revert to Active mode.

### Manual Mode

Manual mode occurs when automation software is lost or has been programmed out (all automation ports have been disabled). Switching from Active mode to Manual mode in this case is automatic.

In Manual mode, the SG-System I receives signals and attempts to send the first signal in the buffer. The unit simultaneously displays the message on the LCD screen, activates the buzzer, and activates the acknowledge LED. To stop the buzzer and the acknowledge LED, the Ack (Acknowledge) button must be pressed and released for every signal not acknowledged in the buffer. The LCD messages received in Manual mode are duplicates of the printer messages. For messages greater than 39 characters, the first 39 characters are displayed. Pressing the Enter button will display the remainder of the message. You are strongly advised to make note of these messages in case any are of a serious nature (e.g. a fire alarm). You must deal with alarms generated while the system is in Manual mode. It is imperative that time spent by the system in Manual mode must be kept to a strict minimum. Note that the alarm printer and automation buffers reside in the SG-System I.

## Program Category

The Program category is accessed in order to program the SG-System I or to view its condition. Sixteen users in total can have access to the unit. User '0' is the Administrator, and has full permissions with regard to using and configuring the unit. All other users - '1~F' - may view system information only, in addition to having the ability to change the time and date displayed on the LCD.

**NOTE: All alarms must be acknowledged via the Ack button before entering Program mode from Manual mode.**

## Password

A password must be entered before the Program category can be accessed. Take the following steps:

1. Press the Enter button while the unit is in either of the Operation modes (Active / Manual) to call up the password field.
2. Enter your 4-digit hexadecimal password on the bottom line (use the Up and Down arrow buttons to scroll through the characters). Note that the default password is 'CAFE'.
3. Press the Enter button to select the desired value and move along to the next digit.
4. Continue until the four spaces are filled. Pressing the Enter button after selecting the fourth digit will automatically present the password to the system for acceptance / rejection.



```

MANUAL 10.0.17.104 14:22 Jan12
ENTER PASSWORD: USER: 0 PASS:XXXX
  
```

Assuming that the password is correct, the SG-System I will enter Program category and generate the corresponding printer and automation signals. Should the password be incorrect, the unit will produce an error tone and return to a Base category (Active mode or Manual mode). Press the Enter button once more to return to the Password screen.

The password can be set in the following manner:

1. Enter the Program category.
2. Scroll to **View or Change Options > CPM Options > Option 006**.
3. Scroll to the user whose password is to be changed. Enter the new password. Press the **Enter** button. The new password is set.

## User Interface

The SG-System I unit's LCD and button interface give the user the ability to program the unit and scroll through the printer buffer and the trouble list. The upper line displays the device mode (in the example below, 'MANUAL'). The lower line displays the system information (in the example below, 'SYSTEM TROUBLE').

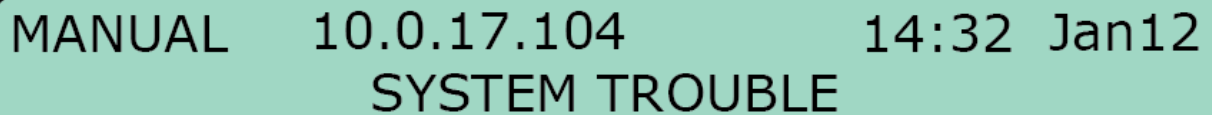

```

MANUAL 10.0.17.104 14:32 Jan12
SYSTEM TROUBLE
  
```

## Top Level Menu

### View or Change Options

In View or Change Options, use the Up and Down arrow buttons to locate the configurable option categories. These categories are: CPM Options / Channel-1 Options / Channel-2 Options / Channel-IP Options / Exit Menu. Please refer to Chapter 4 for a detailed list of the system options available within each category.

```
OPTION      10.0.17.104      14:32 Jan12
1) CPM OPTIONS
```

Select the Exit Menu and press the Enter button. You will return to the View or Change Options level. Pressing the Up and Down buttons simultaneously - regardless of your place within View or Change Options - will take you to the Top Level menu.

### View Printer Buffer

The bottom line of the LCD is cleared when View Printer Buffer is entered. The oldest message in the buffer, including those that have been acknowledged, will be displayed first. Use the Up button to review the older messages and the Down button to review the newer messages. In the case of a lengthy message, the first 39 characters will be displayed. Press the Enter button to show the remainder of the message. This view is available only in Manual mode to review acknowledge messages.

```
BUFFER      10.0.17.104      14:32 Jan12
01 /01  1234 | - Nril / CL40
```

Pressing the Up and Down buttons simultaneously to go to the Top Level menu.

### System Functions

System Functions provides access to the System Functions Menu, which consists of System Information / Change Date and Time / Default SG-System I / Reset SG-System I / Visual Indicator Test / Exit Menu.

### Exit Programming

Pressing the Enter button while in Exit Programming will take the user back to the Active mode or the Manual mode.

## System Functions Menu

### System Information

System Information provides a wealth of detail regarding the user's setup of SG-System I. These details include:

- Version
- ID
- LAN MAC
- LAN IP
- Gateway IP
- SW Checksum
- VHDL Version
- DSP Checksum
- DSP Version
- Manufacture Date
- Country of Manufacture Code
- AHS Table



- IP Accounts

**NOTE:** The number in parentheses represents the number of times the value has been changed or the size of a particular table.

To return to System Information while viewing any of the above, press the Up and Down buttons simultaneously. Pressing the Up and Down buttons once more will take you to the Top Level menu.

### Change Date and Time

Having chosen to enter Change Date and Time by pressing the Enter button, the unit's LCD appears as below:

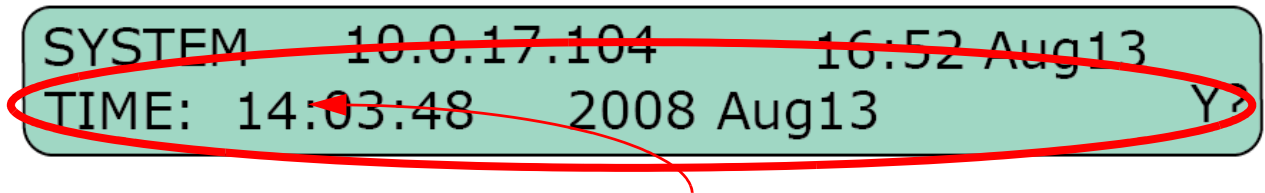

1. Changes to the time and date begin at the far left of the screen with the hour, and proceed to the right. The Up button will increase the value of the digit; the Down button will decrease its value.
2. Having made a change, press the Enter button to advance to the next digit on the right. Pressing the Enter button without having made any changes will also move the cursor to the next digit on the right.
3. Once the Day has been entered and the Enter button pressed, the user will be asked by the SG-System I to confirm the changes: N? for no; Y? for yes. Use the Up and Down buttons to navigate between yes and no.
4. Press the Enter button to save your changes.

**NOTE:** At any point before the time and date have been saved, pressing the Up and Down buttons simultaneously will cancel any unsaved changes and return the user to the System Functions Menu.

### Default SG-System I

When Default SG-System I is selected, the LCD will prompt the user to confirm that the entire system is to be returned to its default values. Selecting Y? for yes will default the system; selecting N? for no will leave system settings as they are. Either of the Up and Down buttons can be used to cycle between answers.

### Reset SG-System I

When Default SG-System I is selected, the LCD will prompt the user to confirm that the entire system is to be reset. This action may be taken to enable a programming change, or to restore an ailing system to working order. Selecting Y? for yes will reset the system; selecting N? for no will leave the system as it is. Either of the Up and Down buttons can be used to cycle between answers.

### Visual Indicator Test

Selecting the Visual Indicator Test turns on all of the LCD pixels and the unit's buzzer, to confirm that they are in good working order.

### Exit Menu

When in **Top Level Menu > Exit Menu**, pressing the Enter button will take the user back one level to the Base (Active mode or Manual mode) level. When in **System Functions Menu > Exit Menu**, pressing the Enter button will take the user back one level to **Top Level Menu > System Functions**. While in System Functions, navigate to Exit Programming. Pressing the Enter button will take the user back to the Base (Active mode or Manual mode) level.

## Miscellaneous LED Indicators

### View Trouble

To enter View Trouble, the unit must first be in Active mode or Manual mode, and have no events to be acknowledged in Manual mode. Press the Up and Down buttons simultaneously to enter View Trouble. Once there, the Up and Down buttons can be used to review the list of

troubles. Should there be no troubles, the LCD will flash **NO TROUBLE** for a few seconds and return to the previous level of operation. A list of possible troubles can be found below.

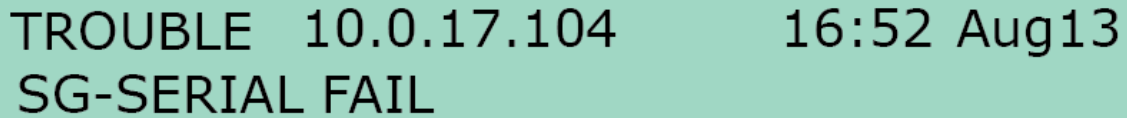

TROUBLE 10.0.17.104 16:52 Aug13  
SG-SERIAL FAIL

### Trouble List

The following trouble and status lists are monitored by the system. Individual troubles can be disabled in the Program category. Both the trouble list and the status list are fully enabled by default.

#### Trouble:

- Parallel Printer
- Serial Printer
- TCP Printer
- USB Printer
- Serial Automation
- TCP Automation
- UPS Battery
- UPS AC
- DSP Failed Ch1
- DSP Failed Ch2

#### Status:

- Line Fault - Channel 1
- Line Fault - Channel 2
- System Absent - Channel 1
- Clock Not Set
- Printer Buffer Full
- Checksum Failed - Software
- DSP Checksum Failed

### View Network / Watchdog

Please refer to **Set Up and Testing on page 18** for detailed Network information.

### View Status

Please refer to **Set Up and Testing on page 18** for detailed Status information.



# 4 Options: System

---

## In This Chapter...

System Option Index on page 29

Steps required to access an option and change its setting or value on page 29

System Options on page 30

## System Option Index

- |  |   |
|--|---|
| Option 001: LAN IP Address on page 30            | Option 024: Mask SG TCP/IP on page 35               |
| Option 002: LAN Subnet Mask Address on page 30   | Option 025: Mask SG Serial on page 35               |
| Option 003: LAN Gateway on page 30               | Option 028: Mask TCP Printer on page 35             |
| Option 004: Auto Update Time and Date on page 30 | Option 029: Mask Parallel Printer on page 36        |
| Option 005: Contrast on page 30                  | Option 02A: Mask Serial Printer on page 36          |
| Option 006: Password on page 31                  | Option 02F: Automation Mode on page 36              |
| Option 007: Automation Baud Rate on page 31      | Option 030: Printer Mode on page 37                 |
| Option 008: Automation Data Bits on page 31      | Option 031: ACK Wait on page 38                     |
| Option 009: Automation Parity on page 32         | Option 032: Date Format on page 39                  |
| Option 00A: Serial Printer Format on page 32     | Options 037 and 038: License Keys #1, #2 on page 39 |
| Option 00B: Serial Baud Rate on page 32          | Option 039: Mask USB Printer on page 39             |
| Option 00C: Serial Data Bits on page 32          | Option 03A: Programmable I/O on page 39             |
| Option 00D: Serial Printer Parity on page 33     | Option 03B: Last Message On on page 40              |
| Option 00E: AHS Operations Time on page 33       | Option 03C: LCD Backlight Colour on page 40         |
| Option 00F: B32 Headers on page 33               | Option 03D: Key Backlight Colour on page 40         |
| Option 012: Heartbeat Timer on page 33           | Option 040: Number of Channels on page 41           |
| Option 013: Buzzer Tone on page 34               | Option 041: System Number Length on page 41         |
| Option 014: Receiver Number on page 34           | Option 042: Busy Out on page 42                     |
| Option 015: Printer Test on page 34              | Option 043: System Protocol ID on page 42           |
| Option 020: Mask UPS AC on page 35               | Option 044: System CLASS Field on page 43           |
| Option 021: Mask UPS BAT on page 35              |   |

## Steps required to access an option and change its setting or value

The steps required to access an option and change its setting or value are very nearly uniform from option to option. The procedure detailed below will match satisfy the majority of options. Those it does not will accept close, intuitive variations of it. Please refer to the steps below when programming system options.

To change an option's setting or value, take the following steps:

1. Turn on the SG-System I.
2. Use the Up and Down buttons to select the user. *User '0' has full administrative powers; all other users may only review system settings, in addition to changing the time and date.*
3. Press the Enter button. This initiates the password sequence, placing a flashing cursor underneath the first digit of the four-digit password.
4. Use the Up and Down buttons to select the appropriate value. Press the Enter button. The cursor will advance to the next digit.
5. Repeat Step 4 for all four digits. If the password you have entered is correct, you now have access to SG-System I. If not, re-enter your password.
6. **View or Change Options** appears on the LCD. Press the Enter button.
7. Use the Up and Down buttons to locate which section of options is valid for your configuration of SG-System I: **CPM Options / Channel-1 Options / Channel-2 Options / Channel-IP Options / Exit Menu**.
8. Press the Enter button. The options applicable to your system are to available for you to access.
9. Navigate to Option XXX. Press the Enter button. The current value is displayed on the LCD.
10. Press the Enter button. The value may now be changed.
11. Use the Up or Down buttons to scroll to the desired value.
12. Having made a selection, press the Enter button.
13. The LCD will prompt you to accept (Y?) or to decline (N?) your changes.
14. Use the Up and Down buttons to select your response. Press the Enter button.
15. Your changes have been saved.

## System Options

### Option 001: LAN IP Address

*Default (10.0.7.200)*

Enter the IP address of the SG-System I. The IP address must be entered as a dotted decimal number (e.g. 255.255.001.000). Each three-digit segment of the IP address must be within a valid range of 000 to 255.

**NOTE: The SG-System I must be restarted for these changes to take effect.**

### Option 002: LAN Subnet Mask Address

*Default (255.255.0.0)*

Enter the LAN Subnet Mask address of the SG-System I. The address must be entered as a dotted decimal number (e.g. 255.255.001.000). Each three-digit segment of the address must be within a valid range of 000 to 255.

**NOTE: The SG-System I must be restarted for these changes to take effect.**

### Option 003: LAN Gateway

*Default (0.0.0.0)*

Enter the LAN Gateway address of the SG-System I. Take care to ensure that the address is unique to your system. The address must be entered as a dotted decimal number (e.g. 255.255.001.000). Each three-digit segment of the address must be within a valid range of 000 to 255. The gateway is used in the event that the data being sent is not on the same network as the SG-System I. The data will need to be sent through a router device. This is the address of that router device.

**NOTE: The SG-System I must be restarted for these changes to take effect.**

### Option 004: Auto Update Time and Date

*Default (0)*

This option enables the automation to update the SG-System I's time via the TCP/IP port. If the SG-System I fails to get the time and date within a twenty-four-hour period (started after the last update is received), it will generate a status message to the printer and automation, following the internal trouble protocol. The Trouble status on the SG-System I display will not be affected.

Printer message: "Time&Date Update Fail"

Automation message: [#0000|NRU0000]

### Option 005: Contrast

*Default (80)*

Use this option to adjust the level of contrast of the unit's LCD. Pressing the *Up* button will increase the contrast, while pressing the *Down* button will decrease the contrast. Alternatively, pressing the *Up* and Enter buttons simultaneously will increase the level of contrast; pressing the *Down* and Enter buttons simultaneously will decrease the level of contrast. Contrast can be adjusted in both Active and Manual modes.

**Option 006: Password***Default (CAFE)*

Use this option to change or delete SG-System I users and their passwords. Sixteen users with 4-digit passwords are available for use on the SG-System I. User 0 is the Master user, with complete administrative control over the system. Users 1 through F may be assigned to individuals within your organization; these sixteen users are able to review system settings but not change them, with the exception of the Time and Date. To delete a user, program the password for that user to 'FFFF'.

**NOTE: User 0 can not be deleted.**

To change your password, take the following steps:

1. Navigate to Option 006.
2. Press the Enter button. The user designation (e.g. '0', 'F') is displayed, in addition to the current password in the form of 'XXXX'.
3. Press the Enter button to begin the process of changing the password.
4. Use the Up and Down buttons to make your selection and press the Enter button. The cursor advances to the next digit.
5. On selecting the fourth digit and pressing the Enter button, the unit LCD will prompt you to accept (Y?) or to decline (N?) your changes.
6. Press the Enter button again to accept or to decline your changes.

**Option 007: Automation Baud Rate***Default (9600)*

This option determines the baud rate at which the SG-System I will communicate to the automation software via serial port 1. As a general rule, the faster the baud rate, the better the unit's performance. Older automation software packages can not, however, manage a fast baud rate and will require a slower baud rate in order to perform at an optimal level. Valid selections are: 1200, 2400, 4800, 9600, 19200, 38400, and 57600.

**NOTE: The SG-System I must be restarted for these changes to take effect.**

**Option 008: Automation Data Bits***Default (8)*

This option determines the number of data bits the SG-System I will use to communicate to the automation software via serial port 1. Valid selections are seven or eight, to indicate seven data bits or eight data bits. As a general rule, the higher the number of data bits, the better the unit's performance.

**NOTE: The SG-System I must be restarted for these changes to take effect.**

**Option 009: Automation Parity***Default (0)*

This option determines the parity of serial port 1.

**Table 5: Automation Parity**

Value	Degree of Parity
0	No parity
1	Odd parity
2	Even parity

**NOTE: The number of stop bits can not be changed and will always be 2.**

**NOTE: The SG-System I must be restarted for these changes to take effect.**

**Option 00A: Serial Printer Format***Default (0)*

This option regulates how data is formatted when sent to a serial printer and how the serial port is supervised. By setting Option 00A to **01**, CTS will need to be set high and print to both HyperTerminal and physical serial printer. By setting Option 00A to **02** (note that this will be displayed as 'DCD' in programming mode), DCD will need to be set high. This option affects how the COM2 serial port is supervised and how the data is formatted. The default value disables the option, blocking the printing of data.

**NOTE: The SG-System I must be restarted for these changes to take effect.**

**Option 00B: Serial Baud Rate***Default (57600)*

This option determines the baud rate at which the SG-System I will communicate to the serial printer via serial port 2. As a general rule, the faster the baud rate, the better the unit's performance. Valid selections are: 1200, 2400, 4800, 9600, 19200, 38400, and 57600.

**NOTE: The SG-System I must be restarted for these changes to take effect.**

**Option 00C: Serial Data Bits***Default (8)*

This option determines the number of data bits the SG-System I will use to communicate to the serial printer via serial port 2. Valid selections are seven or eight, to indicate seven data bits or eight data bits. As a general rule, the higher the number of data bits, the better the unit's performance.

**NOTE: The SG-System I must be restarted for these changes to take effect.**

**Option 00D: Serial Printer Parity***Default (0)*

This option determines the parity of serial port 2. '0' represents no parity, '1' represent odd parity, and '2' represent even parity.

**NOTE: The number of stop bits can not be changed and will always be 2.**

**NOTE: The SG-System I must be restarted for these changes to take effect**

**Option 00E: AHS Operations Time***Default (24)*

Use this option to program at what time the AHS table will be saved to Flash. Backup will occur once every twenty-four-hours at the stated time. When the backup operation is in progress a status message will appear on the LCD, above the time and date. A text message will be sent to the printer when AHS backup starts, stops, or fails.

To set the time - on the hour - at which AHS backup will take place each day, take the following steps:

1. Navigate to Option 00E and press the Enter button.
2. The LCD will, if Option 00E has not previously been altered, mark the option's status as 'OFF'. Use the Up and Down buttons to scroll to a time of day.
3. Select a time of day that you would like AHS backup to begin and press the Enter button. The unit will prompt you to save (Y?) or decline (N?) your changes. Make the appropriate choice and press the Enter button.

**Option 00F: B32 Headers***Default (00)*

This option enables compatibility with MAS B32 Automation Software through TCP/IP. To enable this option, change the value to '01'.

**NOTE: The SG-System I must be restarted for these changes to take effect**

**Option 012: Heartbeat Timer***Default (30)*

Use this option to determine the time interval - measured in seconds - the heartbeat transmission is sent to Serial Automation and TCP/IP port 1025. The heartbeat times is used to ensure that any communication through Serial Automation and TCP/IP is functioning normally when there is no traffic from the receiver. Note that any traffic from the receiver will reset the heartbeat timer. Therefore, the heartbeat transmission will be sent only if there is no signal sent during the time specified in Option 012.



**Option 013: Buzzer Tone***Default (00)*

A tone will sound when the SG-System I, having received an alarm, is unable to forward the alarm message to either the Serial or TCP/IP automation paths (while in Manual mode). You are able to manipulate this tone via Option 013. The tone generated will continue to pulse until all unacknowledged events have been acknowledged by the user; this can be done by pressing the Ack button for each event, or the unit itself transfers from Manual mode to Active mode. If Option 013 is set to '0' or '1', no buzzer tone will sound on receipt of an alarm. Any other value will produce a tone.

**Table 6: Buzzer Tones**

IDX	Frequency (Hz)
20	1490
25	1990
26	2103
30	2650
33	3149
37	3965
38	4270
39	4530

To set the buzzer tone, take the following steps:

1. Navigate to Option 013. Press the Enter button. The current value is displayed on the LCD.
2. Press the Enter button. The value may now be changed.
3. Use the Up and Down buttons to scroll to the desired value.

**NOTE: As each tone is selected the SG-system I will sound that tone for a period of 250 msec, allowing the user the opportunity to judge each tone as it is selected.**

4. Having made a selection, press the Enter button.
5. The LCD will prompt you to accept (Y?) or to decline (N?) your changes.
6. Use the Up and Down buttons to select your answer. Press the Enter button.

**NOTE: Refer to UL864 Programming Requirements on page 10 if changing the default setting.**

**Option 014: Receiver Number***Default (01)*

The receiver number is used to identify the receiver (or, unit) when communicating to the TCP/IP Automation, the Serial Automation, and any connected printer. This receiver number applies to all traffic, unless overridden by another option. In the event that such overriding takes place, it will most likely be a Fallback / Recovery Strategy option.

**Option 015: Printer Test***Default (ON)*

When this option is enabled, a test signal is sent to all active printers at 0500 hrs and 1700 hrs of every day.

Sample printer message: 26 Nov 2003 16:41:25 - 26 Nov 2003-16:41:25-00/00-SG-01-000-0000--Printer Test Message

**Option 020: Mask UPS AC**

*Default (ON)*

Use this option to enable the UPS AC Shelf 1 trouble mask. If enabled, trouble conditions are not reported.

OFF - Condition reported

ON - Condition not reported (masked)

**NOTE:** Refer to *UL864 Programming Requirements on page 10* if changing the default setting.

**Option 021: Mask UPS BAT**

*Default (ON)*

Use this option to enable the UPS Battery Shelf 1 trouble mask. If enabled, trouble conditions are not reported.

OFF - Condition reported

ON - Condition not reported (masked)

**NOTE:** Refer to *UL864 Programming Requirements on page 10* if changing the default setting.

**Option 024: Mask SG TCP/IP**

*Default (OFF)*

Use this option to enable the SG TCP/IP trouble mask. If enabled, trouble conditions are not reported.

OFF - Condition reported

ON - Condition not reported (masked)

**NOTE:** Refer to *UL864 Programming Requirements on page 10* if changing the default setting.

**Option 025: Mask SG Serial**

*Default (OFF)*

Use this option to enable the SG Serial trouble mask. If enabled, trouble conditions are not reported.

OFF - Condition reported

ON - Condition not reported (masked)

See **UL864 Programming Requirements on page 10**.

**Option 028: Mask TCP Printer**

*Default (OFF)*

Use this option to enable the TCP Printer trouble mask. If enabled, trouble conditions are not reported.

OFF - Condition reported

ON - Condition not reported (masked)

See **UL864 Programming Requirements on page 10**.

**Option 029: Mask Parallel Printer***Default (OFF)*

Use this option to enable the Parallel Printer trouble mask. If enabled, trouble conditions are not reported.

OFF - Condition reported

ON - Condition not reported (masked)

**NOTE:** Refer to *UL864 Programming Requirements on page 10 if changing the default setting.*

**Option 02A: Mask Serial Printer***Default (OFF)*

Use this option to enable the Serial Printer trouble mask. If enabled, trouble conditions are not reported.

OFF - Condition reported

ON - Condition not reported (masked)

**NOTE:** Refer to *UL864 Programming Requirements on page 10 if changing the default setting.*

**Option 02F: Automation Mode***Default - Fallback (01)*

The TCP/IP connection is the primary output of the SG-System I for automation computer alarms. It is expected that sockets may appear and disappear regularly as processes are terminated and reconstituted. After five seconds of socket loss, a socket loss is declared and automation output is shifted to the next connection level, which is the serial automation output connection. There are five levels of automation:

**Loop (00)**

At startup, the SG-System I will send to the TCP/IP until it fails, proceed to the RS232 until it fails, proceed back to the TCP/IP until it fails, and so on. Please refer to the Automation Mode workflow diagrams below.

**NOTE:** *This value will not generate an automation absent message.*

**Fallback (01)**

If both outputs are present, the system will send to the TCP/IP connection until it fails, proceeding next to the RS232 connection. It will continue to send to the serial connection without stop, or until the reset fallback command is generated from the console, in which case it will re-try the TCP/IP connection. Please refer to the Automation Mode workflow diagrams below.

**Automatic IP Fallback (04)**

This mode is similar to Fallback, save that when the TCP/IP connection is restored the SG-System I will return to the TCP/IP port to send events. This eliminates the need for the Reset SG Fallback from the SG-System I Console. Please refer to the Automation Mode workflow diagrams below.

**NOTE:** *The SG System I must be restarted for these changes to take effect.*

Figure 6: Loop (00), Automatic IP Fallback (04)

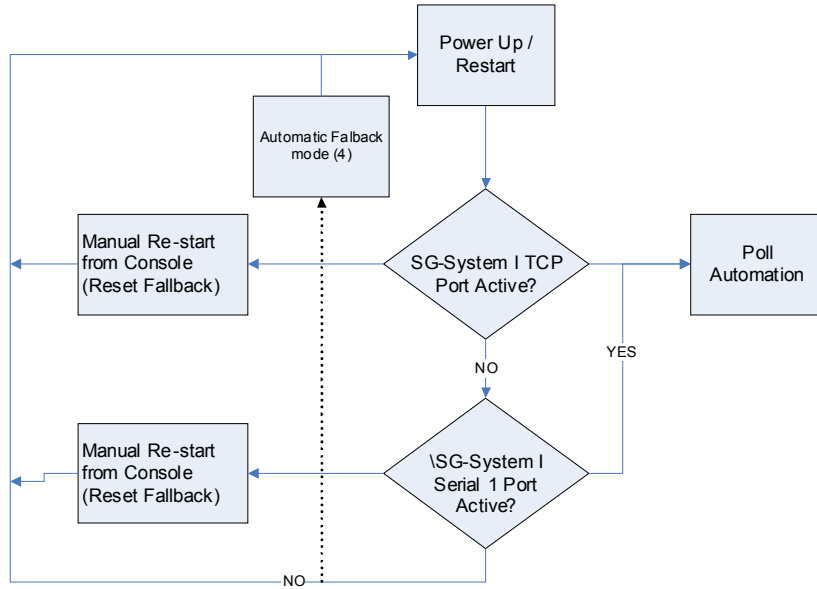
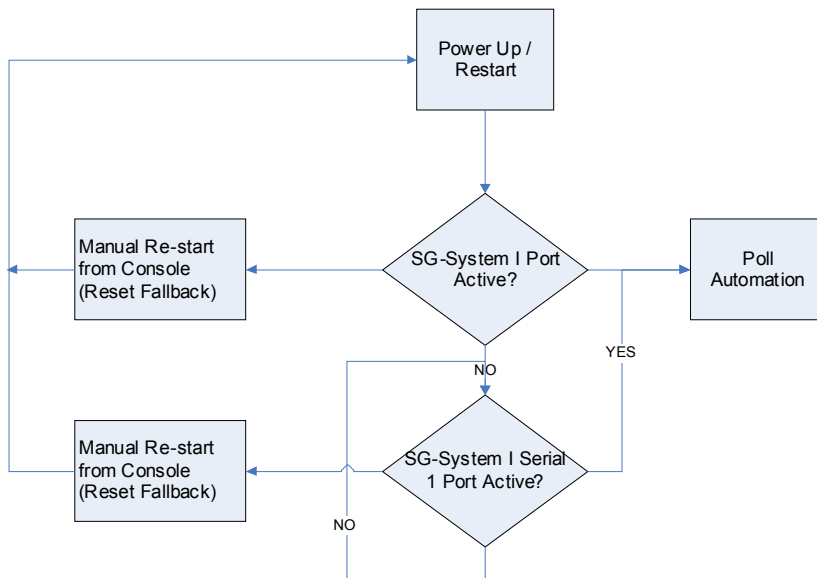
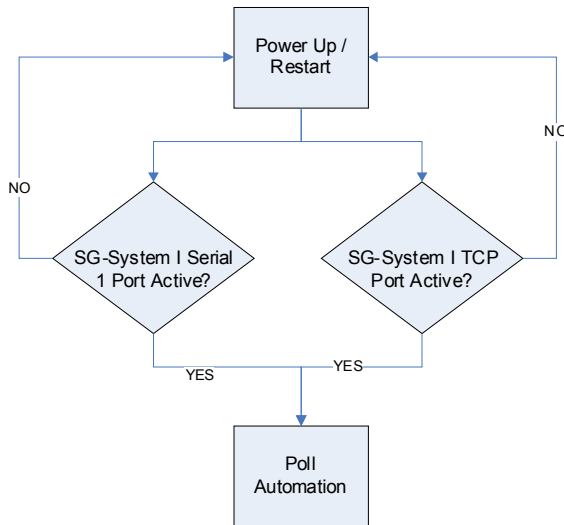

Figure 7: Fallback (01)

**Option 030: Printer Mode***Default (LOOP)*

You can configure this option with an approach similar to the automation outputs of Option 02F above, except that *Fallback (01)* and *Automatic IP Fallback (04)* are **not** available. Acceptable values are *Loop (00)* or *All (02)*. Note that *Loop (00)* transmits printer messages to each port in turn. The first port to respond will be used to process subsequent printer messages until it is no longer able to do so, at which point the next port in the loop will be employed. *All (02)* transmits printer messages to all ports simultaneously.

**Figure 8: All (02)**

**NOTE:** The order of sequence is: TCP, Parallel, USB, and Serial. DSC does not recommend changing the default setting unless using more than one printer.

**NOTE:** The SG System I must be restarted for these changes to take effect.

**NOTE:** Refer to UL864 Programming Requirements on page 10 if changing the default setting.

To set the printer mode, take the following steps:

1. Navigate to Option 030. Press the Enter button. The current value is displayed on the LCD.
2. Press the Enter button. The value may now be changed.
3. Use the Up or Down buttons to scroll to the desired value. Select an integer value from 40 to 99, representing 4.0 seconds to 9.9 seconds. For example, 63 would represent a value of 6.3 seconds.
4. Having made a selection, press the Enter button.
5. The LCD will prompt you to accept (Y?) or to decline (N?) your changes.
6. Use the Up and Down buttons to select your response. Press the Enter button.

**NOTE:** The SG System I must be restarted for these changes to take effect.

### Option 031: ACK Wait

Default (40)

Use this option to determine the acknowledgement wait time, measured in tenths of a second, during which the SG-System I will wait for a response to automation software outputs. If none is received during this interval, the automation software output is retransmitted and the timer reset.

**Option 032: Date Format***Default (DD/MM/YYYY)*

Use this option to determine the format of the date for printer output. Valid entries are 0 and 1.

**Table 7: Date Format**

Value	Output
(0)	<b>International</b> DD / MM / YYYY
(1)	<b>US</b> MM / DD / YYYY

**NOTE:** The SG System I must be restarted for these changes to take effect.

**Options 037 and 038: License Keys #1, #2**

The License Key #1 option allows the user to enter a key that will enable IP Channel functionality on the SG-System I. The License Key #2 option allows the user to enter a key that will enable distinct sellable features on the SG-System I.

**NOTE:** Both keys are required to unlock the IP function.

To enter the license keys, take the following steps:

1. Navigate to Option 037/038. Press the Enter button. The current value is displayed on the LCD.
2. Press the Enter button. The value may now be changed.
3. Use the Up or Down buttons to scroll to the desired value.
4. Having made a selection, press the Enter button. The cursor will advance to the next digit.
5. Repeat Steps 3 and 4 until the full license key has been entered.
6. The LCD will prompt you to accept (Y?) or to decline (N?) your changes.
7. Use the Up and Down buttons to select your response. Press the Enter button.

**NOTE:** If you enter a license key that is incorrect, the receiver will send a 'Invalid License Key' message to the printer. A correct license key will generate no message at all.

**Option 039: Mask USB Printer***Default (ON)*

Use this option to enable the USB Printer mask. If enabled, trouble conditions are not reported.

OFF - Condition reported

ON - Condition not reported (masked)

**NOTE:** Refer to UL864 Programming Requirements on page 10 if changing the default setting.

**Option 03A: Programmable I/O***Default (00)*

**NOTE:** SG-System I version 1.0 has the inputs and outputs hard set. Later versions will permit user access to unit inputs and outputs.

I/O interface connections are located at the back of the unit and employ a screwless, spring-type terminal. There are three outputs and four inputs on the unit. Relays are employed for the output switching of the SG-System I unit. I/O functions are described at item 14 of the **Table 3: SG-System I Front and Rear Panel Descriptions** on page 15.

**Option 03B: Last Message On***Default (Off)*

When enabled, this option displays the most recent printer message on the lower line of the unit LCD. It will remain there until a new printer message replaces it. The automation condition - e.g. mode (Active / Manual) or slot (all / TCP / Serial) - does not have any effect on this feature.

**Option 03C: LCD Backlight Colour***Default (Cyan)*

You can use this option to select the LCD backlight colour. Available colours are: OFF / WHITE / GREEN / BLUE / MAGENTA / CYAN / ORANGE / PURPLE / AQUA / PINK / ROYAL / FADE / CYCLE.

When accessing this option, the available colours will appear on the LCD as you cycle through them, providing a preview of their effect. This is done without your needing to exit the menu.

**Table 8: LCD Backlight Colour**

Colour	Description
Off	Light grey.
White ~ Royal	As per its name.
Fade	A static blend of all available colours from white to royal.
Cycle	Rotates through all available colours from white to royal at one second intervals.
Yellow	Reserved for Trouble mode.
Red	Reserved for Manual mode.

**Option 03D: Key Backlight Colour***Default (Cyan)*

You can use this option to select the LCD backlight colour. Available colours are: OFF / WHITE / GREEN / BLUE / MAGENTA / CYAN / ORANGE / PURPLE / AQUA / PINK / ROYAL / FADE / CYCLE.

When accessing this option, the available colours will appear on the LCD as you cycle through them, providing a preview of their effect. This is done without your needing to exit the menu.

**NOTE: Please refer to Table 8: LCD Backlight Colour on page 40.**

**Option 040: Number of Channels***Default (C1+C2)*

Use this option to determine the number of channels to be polled by the SG-System I. Valid entries range from 01~05.

**Table 9: Number of Channels**

Number of channels	Description	UL864
C1	Only one channel of POTS is used. All reporting of trouble / status conditions for the second line will be masked and the channel will be indicated as busy.	-
C1 + C2	Both POTS channels are used. No IP communication will be possible with this setting. The Alarm port will be indicated as busy. Trouble / status conditions will be masked for the IP channel.	UL
C1 + C2 + IP	Both POTS channels and the IP channel will be polled. IP functions will be available only if they have first been unlocked.	UL
C1 + IP	One POTS channel and the IP channel will be polled. IP functions will be available only if they have first been unlocked. All reporting of trouble / status conditions for the second line will be masked and the channel will be indicated as busy.	UL

**NOTE:** Refer to *UL864 Programming Requirements on page 10* if changing the default setting.

**Option 041: System Number Length***Default (0A)*

Use this option to determine how many digits from the line card number will be sent to the output. You can make the option display these digits in hexadecimal or decimal. In a small environment with a limited number of receivers, the default value will suffice. In a large environment with a large number of receivers, this option provides useful flexibility. Possible values are listed in the table below.

**Table 10: System Number Length**

Value	Description
01	Sends a one digit hexadecimal number to the printer or computer output (a two-digit line card number will have only the first digit sent to the output). If using DNIS, replace with RRLLL. The output will now be three digits of RRL.
02	Sends a two-digit hexadecimal line card number to the output. If using DNIS, replace with RRLLL. The output will now be four digits of RRL.
03	Sends a three-digit hexadecimal line card number to the output (leading zeroes will be inserted as a suffix to the line card number). If using DNIS, replace with RRLLL. The output will now be five digits of RRL.
0A	Sends a three-digit line card number as entered (no conversion). If using DNIS, replace with RRLLL. The output will now be five digits of RRL.
0D	Sends a three-digit line card number in decimal (conversion from hexadecimal to decimal). If using DNIS, replace with RRLLL. The output will now be five digits of RRL.

**NOTE:** This option should always correspond to the number of DNIS digits being received. E.g. If five digits are being received, this option should be set to three. This will force the five digits of DNIS DDDDD to overwrite the standard RRLLL.



**Option 042: Busy Out***Default (00)*

Enabling this option allows the line card to seize the phone line in case of a checksum error after download or when its internal buffer is full after a loss of communication with the system.

- **00** - the line is seized if either of the conditions mentioned above occur.
- **01** - the line is *not* seized if either of the conditions mentioned above occur.
- **04** - the line will be seized immediately if the automation computer is absent.
- **05** - the line will be seized immediately if the automation computer is absent or there is no communication with the system, but only if the internal computer (automation) buffer is full. If there is a loss of a printer(s) and the printer buffer is also full, any new alarms will not be buffered in the internal printer buffer. The SG-System I has two independent buffers, computer and printer.

**NOTE: If this option is set to 01, the line card will not buffer any new alarms once the internal buffer is filled. Setting option 042 to this value is not recommended.**

**NOTE: Refer to UL864 Programming Requirements on page 10 if changing the default setting.**

**Option 043: System Protocol ID***Default (0)*

Use this option to ensure that your automation software performs as desired.

**NOTE: Note that some automation software packages expect the '0' format, while other automation software packages expect the 'S' format.**

RS-232 Format

S,0 (zero): protocol number

RR: Receiver number

LLL: Line number

AAAA: Account code, always 0000

Nxxyy = SIA event

[00] - Output for all internal signals is SRRL protocol.

SRLLLL[#AAAA|Nxxyy]

[01] - Output for all internal signals is 0RRL (Zero) protocol.

0RLLLL[#AAAA|Nxxyy]

[02] - Output signals in automation protocol SRRL with leading space in the zone (DVACS only).

[03] - Output signals in automation protocol 0RRL (zero) with leading space in the zone (DVACS only).

**Option 044: System CLASS Field***Default (04)*

Use this option to determine what aspect of CLASS field data is sent to the printer and the automation software. Your choices are detailed in the table below:

**Table 11: System CLASS Field Data**

Value	Description
00	Sends zeroes from the CLASS field of the Con Comm / RBUS packet.
01	Sends the Receiver Line Card Number (RRLLL) from the CLASS field of the Con Comm / RBUS packet.
02	Sends DNIS from the CLASS field of the Con Comm / RBUS packet.
03	Sends Caller ID from the CLASS field of the Con Comm / RBUS packet.
04	Sends the value Option 012: Caller Source is set to from the CLASS field of the Con Comm / RBUS packet.
05	Sends the convert data from the DNIS / Caller ID (combined) Conversion table from the CLASS field of the Con Comm / RBUS packet.

For example:

In an arbitrary situation, value 02 has been selected; the DNIS is 99802.

Automation software output will be: **S99802|1234|NBA0F10|**

Printer output will be: **03 Jun 2007 08:33:33 - 03 Jun 2007-08:33:32-01/01-SG -99-802-1234--Alarm Zone**



# 5 Options: Channels 1 and 2

---

## In This Chapter...

[Channel Option Index on page 45](#)

[Steps required to access an option and change its setting or value on page 46](#)

[Static Options on page 46](#)

[Dynamic Options on page 54](#)

## Channel Option Index

### *Static Options on page 46*

- Option 101: Line Card Number on page 46
- Option 104: Two-Way Activation Time on page 46
- Option 105: Pre-H.S. Duration on page 47
- Option 109: First Ring Length on page 47
- Option 10D: Ring Select on page 47
- Option 10E: Backup Line Option on page 47
- Option 111: Hook Flash Enable on page 48
- Option 112: Caller Source ID on page 48
- Option 113: Caller Source to SG Automation on page 49
- Option 114: Caller Source to Printer on page 49
- Option 117: DMP User Length on page 50
- Option 118: DMP User Length on page 50
- Option 119: Fault Call Counter on page 51
- Option 11A: DNIS Input Sensitivity on page 51
- Option 11F: Debug Option on page 52
- Option 125: Phone Line Voltage Select on page 52
- Option 12C: Dialer Presence on page 53
- Option 12D: AHS on page 53
- Option 12F: Online Timeout on page 53

### *Dynamic Options on page 54*

- Options 130-13F: 3/1 - 4/1 Digit 0-F on page 54
- Options 140-14F: 3/2 - 4/2 Digit 0-F on page 54
- Options 150-15F: 4/3 Digit 0-F on page 54
- Options 160-16F: Printer Words on page 55
- Option 170: Automation Common Event Code on page 55
- Option 171: Library Select on page 56
- Option 172: SIA Option on page 57
- Option 173: Input/Output Sensitivity on page 59
- Option 174: Equivalent Line Number on page 59
- Option 175: Receiver Number on page 59
- Option 176: Accounts 3/x - 4/x on page 59
- Option 177: Digit Replace on page 60
- Option 178: Maximum Inter-Digit on page 60
- Option 179: Maximum Inter-Burst on page 60
- Option 17A: Four- and Five-Digit Account Codes To Activate Two-Way Radio on page 61

- Option 17B: Three-Digit Account Codes To Activate Two-Way Radio on page 61
- Option 17C: Audio Alarm Code Range on page 61
- Option 17D: Audio Zone Code on page 62
- Option 17E: Audio RS-232 on page 62
- Option 17F: Audio Format on page 62
- Option 180: Kiss-off to Hang-up on page 63
- Options 181 - 188: Handshake Selection on page 63
- Options 189 - 190: Handshake and Kiss-off Duration on page 66
- Option 191: Inter-Handshake Duration on page 66
- Option 192: Pulse Mode on page 67
- Option 193: Minimum Audio Tone on page 67
- Option 194: Account Digit Stripping on page 67
- Option 195: Five- and Six-Digit Pulse on page 69
- Option 196: 4/1 Extended on page 70
- Option 197: 4/2 Extended on page 70
- Option 198: 3/1 Extended on page 70
- Option 199: Ademco Express on page 71
- Option 19A: Error Counter on page 71
- Option 19B: Echo Canceller on page 71
- Option 19C: Acron RS-232 on page 71
- Option 19D: Modem II RS-232 on page 72
- Option 19E: Scantronics Select on page 72
- Option 19F: Ademco High Speed RS-232 on page 72
- Option 1A0: 11-/12-Digit DTMF (Acron, Scantronics, or Scancom 433) on page 73
- Option 1A1: FBI RS-232 on page 74
- Option 1A2: Digit Replace on page 74
- Option 1A3: D6500 RS232 on page 74
- Option 1A4: BFSK RS-232 on page 75
- Option 1A5: SESCOA Super Speed on page 76
- Option 1A6: ITI Adjust on page 76
- Option 1A7: Silent Knight FSK2 RS-232 on page 76
- Option 1A8-1AF: Dial-Out Number for Two-Way Audio Transfer on page 77
- Option 1B0: CCITT Audio Format Enable Bits on page 78
- Option 1B1: DMP Area BIN or DEC Option on page 78
- Option 1B2: Format Disable on page 79

**NOTE:** The options available for channels 1 and 2 are identical. The only difference is in the prefix: channel 1 options begin with the digit '1' (e.g. 102); channel 2 options begin with the digit '2' (e.g. 202).

## Steps required to access an option and change its setting or value

The steps required to access an option and change its setting or value are very nearly uniform from option to option. The procedure detailed below will satisfy the majority of options. Those it does not will accept close, intuitive variations of it. Please refer to the steps below when programming system options.

To change an option's setting or value, take the following steps:

1. Turn on the SG-System I.
2. Use the Up and Down buttons to select the user. *User '0' has full administrative powers; all other users may only review system settings, in addition to changing the time and date.*
3. Press the Enter button. This initiates the password sequence, placing a flashing cursor underneath the first digit of the four-digit password.
4. Use the Up and Down buttons to select the appropriate value. Press the Enter button. The cursor will advance to the next digit.
5. Repeat step 4 for all four digits. If the password you have entered is correct, you now have access to SG-System I. If not, re-enter your password.
6. **View or Change Options** appears on the LCD. Press the Enter button.
7. Use the Up and Down buttons to locate which section of options is valid for your configuration of SG-System I: **CPM Options / Channel-1 Options / Channel-2 Options / Channel-IP Options / Exit Menu.**
8. Press the Enter button. The options applicable to your system are to available for you to access.
9. Navigate to Option XXX. Press the Enter button. The current value is displayed on the LCD.
10. Press the Enter button. The value may now be changed.
11. Use the Up or Down buttons to scroll to the desired value.
12. Having made a selection, press the Enter button.
13. The LCD will prompt you to accept (**Y?**) or to decline (**N?**) your changes.
14. Use the Up and Down buttons to select your response. Press the Enter button.
15. Your changes have been saved.

## Static Options

### Option 101: Line Card Number

*Default (Channel Number)*

Use this option to provide a virtual identification code for each SG-SYSTEM I module. Hexadecimal numbers **01** to **FE** can be programmed in Options 101 and 201 to identify line cards.

### Option 104: Two-Way Activation Time

*Default (0A)*

Use this option to determine how long, in 10-second increments, the 2-way audio function will be active once it is initiated. At the end of this time, the line card will hang up the line. Program a value from **01** to **FF** (1-255 sec). Three minutes is the recommended length of time for the 2-way audio activation time. To disable the 2-way audio feature, program this option as **00**.

**NOTE: Enabling 2-way audio will affect NFPA 72 system loading requirements. Refer to Par. 4-5.3.2.2.2 of NFPA 72 for details.**

**NOTE: If the alarm panel sends a listen-in code activation request and audio is enabled for this format (Option 7F or B0), the receiver will remain in 2-way voice for a period of 60 seconds, even if the activation time is not programmed.**

**Option 105: Pre-H.S. Duration***Default (0A)*

This option is useful in the case of a system in which the phone line needs time to settle before functioning properly. The default value will in most circumstances work satisfactorily.

Enter a value for the amount of time the system is to wait before establishing a handshake. When the line card seizes the line, it will wait for this amount of time before sending the first handshake. The value set for this option (in hexadecimal) will be multiplied by 100 msec. The minimum value allowed by the system is one second; any entered value less than that will use a one second delay by default.

**Option 109: First Ring Length***Default (05)*

The value you set for this option is dependent on the country in which the SG-System I is located, and the type of ring - single vs. double - employed there by that nation's telephony. The value for this option may be reduced if the system has difficulty catching the call. Set the value too low, however, and false calls set off by lightning, electrical shorts, etc., may be encountered.

In order for the line card to detect an incoming ring, the ring signal must be on for a minimum amount of time. Use this option to change the minimum amount of time the ring signal must be on before the receiver will detect a valid ring length. Minimum ring duration is 200 msec, which corresponds to a value of **02**. Values of **00** and **01** give a default ring length of one second. Programmed values are multiplied by 100 msec.

**Option 10D: Ring Select***Default (00)*

Use this option to enable or disable the double ring detection. If set as **00**, the line card will detect a single ring. If set as **01**, the line card will detect the double ring.

**Option 10E: Backup Line Option***Default (00)*

Use this option to enable or disable each channel's backup line. If this option's value is set as '00', the backup is disabled. If the option is set as '01', the backup is enabled. If a line fault should occur on a primary channel while the option is enabled, the line card will switch over to the auxiliary line to allow normal operation. If at any time the primary line is restored, the line card will complete its online operation - if it is communicating with a panel at the time - and afterwards switch back to the primary line.

With this option enabled, the LCD line fault messages will change. The table below illustrates how the LCD messages will appear:

**Table 12: Line Fault Messages**

Primary Channel	Auxiliary Channel	Line Fault LCD	Active Line
Not in line fault	Not in line fault	OFF	Primary
Not in line fault	In line fault	OFF	Primary
In line fault	Not in line fault	OFF	Auxiliary
In line fault	In line fault	ON	None

**Line Fault and Line Restoral Messages**

The line fault and line restoral messages - as they appear in the manner of a computer message - are identical for a primary line and an auxiliary line. Line fault and line restoral messages for a primary line and an auxiliary line, as they appear on a printer message, will differ. Printer messages for the auxiliary line differ in that the text 'LINE 2' will appear in them.

E.g. Nov 17 2007 - 08: 08: 35-SS/OO-SG-RR-LLL-0000-PHONE LINE 2 RESTORE  
 Nov 17 2007 - 08: 08: 35-SS/OO-SG-RR-LLL-0000-PHONE LINE 2 TROUBLE

**NOTE: If Option 10E is enabled, two-way radio will not be available through the auxiliary channel. If two-way audio is required, the channel's hookflash operation must be employed. Please refer to Option 111: Hook Flash Enable on page 48.**

**Option 111: Hook Flash Enable**

Default (00)

Use this option to enable or disable the ability to hookflash the telephone line. You can also use this option to set the duration of the hookflash (in increments of ten msec). The ability to set the duration of the hookflash allows the the SG-System I to be configured to work correctly on a wide variety of telephony systems and environments. If programmed as **00**, the option is disabled. If set to any other value, multiply the decimal equivalent of the hexadecimal value by 10 msec to arrive at the true duration of the hookflash. For example, to achieve a hookflash time of 500msec, set Option 111 to **32** hexadecimal.

**Option 112: Caller Source ID**

Default (00)

Use this option to allow the line card to receive caller identification data or DNIS that are transmitted from the call source after the first ring of the telephone line. Note that the appropriate service must be available and requested from your telephone company before this feature can be operational. Option settings and descriptions of each are located in the table below.

**Table 13:Caller ID**

Setting	Description
00	Disabled.
01	Standard Bellcore Caller ID.
0X	Receive DTMF DNIS (The second digit is the amount of DNIS digits received, not including their terminator. Valid entries are 4~A.).
10	Select ETSI DTMF Caller ID. In this mode the primary incoming line must be connected to both primary and backup connectors for phone line detection.
11	Select ETSI DTMF Caller ID or Bellcore. In this mode the primary incoming line must be connected to both primary and backup connectors for phone line detection.
2X	Receive X DNIS and ANI in <DNIS>T<ANI> T format, where T = terminator digit (any hexadecimal digit B - F). the low nibble X must be 4 to A.
4X	Receive ANI and X DNIS in <ANI>T<DNIS>T format, where T = terminator digit (any hexadecimal digit B - F). the low nibble X must be 4 to A.

General messages other than Caller ID or DNIS may be received and decoded by the receiver.

- Private Call: An anonymous indication is received instead of the originating telephone number.
- No Call Number: An out-of-area or unavailable indication is received instead of the originating telephone number.

- Unknown Call: The originating telephone number has not been received, or was not transmitted.

**NOTE:** A nibble is half a byte. Of the byte AF, 'A' is the high nibble, 'F' is the low nibble.

### Option 113: Caller Source to SG Automation

Default (00)

Use this option to enable the transmission of Caller ID or ANI to the software automation output. Possible values are as follows:

**Table 14: Caller Source to Automation**

Protocol	Format	Description
00		Do not send to the automation software.
01	4RRLL	Send to the automation software (North American Caller ID).
02	URRLLL	Send to the automation software (International Caller ID).
04	uRRLL	Send ANI information to the automation software.
05	uRRLLL	Calling Name protocol ID.

**NOTE:** Option 112 must be programmed for Caller ID (01) or ANI (4X or 2X, where 'X' represents the number of DNIS digits).

### Option 114: Caller Source to Printer

Default (00)

Use this option to enable the transmission of Caller ID or ANI to the printer output. Possible values are as follows:

**Table 15: Caller Source to Automation**

Protocol	Format	Description
00		Do not send to the printer.
01	4RRLL	Send to the printer. Each alarm will print an extra line, displaying the Caller ID (North American Caller ID).
04	4RRLL	Send to the printer. Each alarm will print an extra line, displaying the ANI number.

**NOTE:** Option 112 must be programmed for Caller ID (01) or ANI (4X or 2X, where 'X' represents the number of DNIS digits).



**Option 117: DMP User Length***Default (00)*

Use this option to set the length of user numbers and zone numbers. The first digit in the option represents the user number; the second digit represents the zone number. For example, if a value of '24' is set for Option 117, the receiver will output a 2-digit user number and a 4-digit zone number.

Note that the default value of **00** will generate an arbitrary 2-digit user number and a 2-digit zone number.

User numbers and zone numbers are limited to four digits in length. Values greater than '4x' or 'x4' will use the default 2-digit user number and zone numbers.

**NOTE: Option 117 affects DMP Serial 1 format, but not DMP Serial 3.**

**Option 118: DMP User Length***Default (00)*

Use this option to determine how the 4/3 format computer output string is formatted. Use the first of two nibbles to combine the user and group codes for openings and closings. When set as '1x', group arming/disarming signals will be combined with the user code into one signal. This will be sent to the computer.

For example, the following information may be sent to the computer (Note that the printer output does not change).

Printer:

1234-B01 CloseGrp

1234-416 Close

1234-C02 OpenGrp

1234-532 Open

Computer:

1234 C1 16 (replacing 1234 C 01 and 1234 C 16)

1234 O2 32 (replacing 1234 O 02 and 1234 O 32)

If a user code is not received after the group opening/closing, the message '1234 C1 FF' will be sent; the 'FF' segment indicates that a user code was not received.

Use the second of two nibbles to control the user/zone number conversion. The Sur-Gard 4/3 DTMF format is made up of a 4-digit account code, a 1-digit event code, and a 2-digit hexadecimal zone code or user number. Some central station software packages, however, use a common event code and require user codes in a decimal format. This option allows the user codes to be converted from hexadecimal to decimal in order to meet the needs of their central station software.

Enter one of the following four values:

**x0** Sends the last two digits as user codes without conversion.

**x1** Converts the last two digits of the user codes to decimal.

**Table 16:DTMF 4/3 Format Output**

Original User Code	User Code after Conversion
00 to 99	00 to 99
B0 to B9	100 to 109
C0 to C9	110 to 119
D0 to D9	120 to 129

**Table 16:DTMF 4/3 Format Output**

Original User Code	User Code after Conversion
E0 to E9	130 to 139
F0 to F9	140 to 149

For example, if '1234 4B1' is received, '1234 C 101' will be sent to the computer.

**x2** Sends the last three digits as the zone code. The 5th digit will continue to be used as the event code.

For example, if '1234 161' is received, '1234 A 161' will be sent to the computer.

In the case of individual event codes, if '1234 401' is received, '1234 C 01' will be transmitted to the computer. When common event codes are used, if '1234 401' is received, '1234 Z 401' will be transmitted to the computer. **Z** is the common event code.

**x3** Sends the last three digits as the zone codes, and converts only the user codes to decimal.

When the first nibble of the option is set to '1', the three-digit user codes will be combined with the group number as follows:

Code received	Code sent to computer
1234B01	No transmission
12344B1	1234 C1 101

### Option 119: Fault Call Counter

*Default (00)*

Use this option to limit the number of Fault Call messages that are sent to the printer and the computer. Two choices are available:

- 00 - One Fault Call alarm will be sent for every ten Fault Calls received. When the SG-System I is turned on, the channel will send on the first Fault Call received and every ten after that.
- 01 - Every fault Call alarm is sent to the automation software and the printer.

### Option 11A: DNIS Input Sensitivity

*Default (00)*

DNIS noise levels can differ considerably from telephone line conditions, resulting in an incorrectly decoded DNIS. It may therefore be necessary to configure the telephone line sensitivity for the reception of DNIS signals.

**Table 17: DNIS Input Sensitivity**

Value	Sensitivity
00	-35db
0F	-42db ~ 0db
3F	-35db ~ 0db
FF	-29db ~ 0db

**NOTE: Do not change this option unless instructed to do so by DSC Technical Support.**

**Option 11F: Debug Option***Default (01)*

Use this option to control the flow of debug messages to the SG-System I debug port.

Option 11F is a bitwise option, meaning that more than one of the available settings may be enabled. Enabling all settings, however, is not recommended, as it will adversely affect the performance of the unit.

**NOTE: Please contact DSC technical support before attempting to access this option.**

**Option 125: Phone Line Voltage Select***Default (00) - for approximately 20V*

Use this option to program the minimum voltage level of the phone line. To calculate the setting, use the following formula:

*Phone Line Voltage = 2000 / Option 125.*

For example, to set the phone line voltage to 15V:  $2000/15 = 133$ ; therefore set Option 25 = 0x85

The debounce to detect a line fault is **5**.

This option must be between **50** and **250**, otherwise the default of 100 (0x64) = 20V will be used.

Note that it is not advised to decrease the voltage level to < 20V, as this adversely affects the timing of ring detection and *may* cause the channel to fail to detect rings.

**Option 127: Caller Source Process***Default (05)*

Use this option to determine how many digits of Caller ID or DNIS - dependent on Options 112/212 - the SG-System I will process. Available values range from **00** ~ **0A**, in hexadecimal. This translates into an decimal range of 0 ~10.

**Option 12A: Hook Flash Delay***Default (00)*

Use this option to set the delay, after dialling, before the receiver will go back on hook. This option contains two levels of resolution controlled by the upper nibble.

00 = no delay

01 - 5F = 100msec to 9500msec.

A1 - AF = 10sec to 150sec

xx = 9500msec.

Examples:

If a Hook Flash Delay Time of 500msec is desired, program Option 12A to 05 hexadecimal.

If a Hook Flash Delay Time of 120sec is desired, program Option 12A to AC hexadecimal.

**Option 12C: Dialer Presence***Default (00)*

With this option you can determine how your SG-System I will handle dialer presence; that is, distinguishing between an animate caller (person) and an inanimate caller (machine). Select from among the three possible values below:

- 00 - Disabled.
- 01 - The receiver will begin its handshake sequence only when a valid dialer presence tone is received.
- 02 - The receiver will begin its handshake sequence after a valid dialer presence tone is received, or a timeout occurs. Timeout occurs after five seconds.

**NOTE: When this option is enabled, Option 105 is disabled. This is done in order to synchronize the handshakes sent out by the receiver.**

**Option 12D: AHS***Default (00)*

Use this option to enable or disable Automatic Handshake Selection, the process of the line card sending a handshake to be used with the ANI (a method of identifying the calling party). The handshake is sent immediately, as it remembers the details of the incoming panel. This option increases the speed at which the line card can operate, reducing overall system response times. Valid AHS values are listed immediately below:

- 00 - AHS is disabled
- 01 - AHS is enabled, ten digits in length
- 02 - AHS is enabled, with no limit to its length

AHS can also be used in conjunction with with the DNIS to select a predefined profile based on the DNIS table that is stored on the line card. The handshake is retrieved from the AHS table, with the remainder of the information taken from the DNIS profile. Should the panel not respond to this handshake given by the line card, the panel will proceed with its handshake sequence from this profile, as opposed to the default profile.

This option would likely be disabled in a small environment, one not using Caller ID or DNIS.

**Option 12F: Online Timeout***Default (1E)*

Use this option to enable or disable the online timeout, and if enable to set the time at which the timeout will occur. The timeout range can be programmed from 01 to 255 seconds (hexadecimal **01 - FF**), or until the call is completed by the panel (hexadecimal **00**). When the timeout occurs, the line card will hang up and generate a signal to both the printer and the automation software (SIA identifier SA).

E.g. Printer Message: **DRL Online Time-Out**  
Automation Software: **NYS0102 (shelf 01, slot 02)**

**NOTE: Refer to UL864 Programming Requirements on page 10 if changing the default setting.**

## Dynamic Options

### Options 130-13F: 3/1 - 4/1 Digit 0-F

*Default - Options 130-138 (A); 139 (R); 13A (A); 13B (O); 13C (C); 13D (\); 13E (R); 13F (T)*

Use these options to enable your computer software to recognise different alarm types. The line card uses a unique Sur-Gard communication format to transmit data through the System to the central station computer. Event codes corresponding to alarm codes in 10 to 40 Baud formats and DTMF 4/1 to 4/3 formats are used to enable the computer software to determine alarm types.

The SG-System I uses the last digit of data received in 3/1 and 4/1 formats to determine the computer event code. The event code will then be transmitted to the central station computer. Refer to the Decoding Library for the complete set of event codes used by the line card. For Options 130-13F, program ASCII codes according to the Decoding Library.

**NOTE: Do not use values other than 20-7F (ASCII).**

### Options 140-14F: 3/2 - 4/2 Digit 0-F

*Default - Options 140-148 (A); 149 (R); 14A (A); 14B (O); 14C (C); 14D (\); 14E (R); 14F (T)*

Use these options to enable your computer software to recognise different alarm types. The line card uses a unique Sur-Gard communication format to transmit data through the System to the central station computer. Event codes corresponding to alarm codes in 10 to 40 Baud formats and DTMF 3/2 to 4/2 formats are used to enable the computer software to determine alarm types.

The SG-System I will use the first digit following the account code in 4/2, 3/1 extended, or 3/2 formats to determine the computer event code. The event code will then be transmitted to the central station computer. Refer to the Decoding Library for the complete set of event codes used by the channel. For Options 140-14F, program ASCII codes according to the Decoding Library.

**NOTE: Do not use values other than 20-7F (ASCII).**

### Options 150-15F: 4/3 Digit 0-F

*Default - Options 150-158 (A); 159 (R); 15A (A); 15B (O); 15C (C); 15D (\); 15E (R); 15F (T)*

Use these options to enable your computer software to recognise different alarm types. The line card uses a unique Sur-Gard communication format to transmit data through the System to the central station computer. Event codes corresponding to alarm codes in 10 to 40 Baud formats and DTMF 4/3 format are used to enable the computer software to determine alarm types.

The SG-System I will use the fifth digit of data received in 4/3 format to determine the message and event code. The event code will then be transmitted to the central station computer. Refer to the Decoding Library for the complete set of messages and event codes used by the line card. For Options 140-14F, program ASCII codes according to the Decoding Library.

**NOTE: Do not use values other than 20-7F (ASCII).**

**Options 160-16F: Printer Words***Defaults***Table 18: Printer Words**

Option	Default Values	Output
160	F2	Periodic Test Report
161	0A	Fire Alarm
162	14	Panic Alarm
163	1E	Burglary
164	63	Closing
165	62	Opening
166	E5	Service
167	00	Medical
168	E4	Message
169	61	Restore
16A	F2	Periodic Test Report
16B	C6	Group Closing
16C	C7	Group Opening
16D	E6	Zone Bypass
16E	50	System Trouble
16F	A6	Cancel

You can use these options to modify the printer output according to the particular requirements of an event code. The English Printer Library is provided and can be selected by matching the event codes to the corresponding word. For example, if the words 'System Trouble' are required when the alarm code 1 is received in 3/1 (or 4/1 formats), Option 161 must be programmed as **50**.

Please refer to **Printer Words on page 102** for a definitive list of available words.

**NOTE: You must enable Option 171: Library Select in order to use Options 160-16F: Printer Words.**

**Option 170: Automation Common Event Code***Default (00)*

Some central station software packages are unable to process an alarm using the event codes listed in the Decoding Library. Where a central station monitors thousands of accounts belonging to different companies, the same reporting codes may have different meanings for different companies. Because of this, the individual event codes in Options [130] through [15F] cannot accurately represent the alarm condition. To overcome this, Option [170] may be programmed as indicated below:

Program Operation:

00 - Use individual event codes to computer.

20, 30-39 & 41-5A - Use common event codes (space, 0-9, A-Z). When using common event codes, DSC recommends that either hexadecimal code '5A' (ASCII 'Z') or hexadecimal code '41' (ASCII 'A') be used. The 'Space' character (Hex 20) can be used as the common event code with certain automation software packages to avoid account code database changes when switching over from other brand receivers to the Sur-Gard receiver.

B0-DF ('0'-'9', 'A'-'Z' with the most significant bit set). This range will function in the same way as 30-39, 41-5A, with the exception that, for the Superfast Ademco Format, the Printer Message text will not be output.

For example:

"01-002-1234-A4-".

### Option 171: Library Select

*Default (04)*

Use this option to determine how to make the best use of the Printer Words options.

**Table 19:Library Select**

Value	Description
00	No printer words.
01	Printer words options used for 1-digit reporting code formats only; other's will use pre-defined library.
02	Printer words options used for 2-digit reporting code formats only; others will use pre-defined library.
03	Printer words options used for 3-digit reporting code formats only; others will use pre-defined library.
04	Printer words options used for 1-digit and 2-digit reporting code formats only; others will use pre-defined library.
05	Printer words options used for 1-digit, 2-digit, and 3-digit reporting code formats.

**NOTE: Option 171 is disregarded when using SIA, ITI, Contact-ID, ACRON, MODEM II, MODEM IIE, MODEM IIIa<sup>2</sup>, FBI SuperFast, BFSK, ADEMCO Super Fast, and SK FSK1, 2 formats.**

**Option 172: SIA Option***Default (00000)*

Use this option to convert incoming signals to SIA - Security Industry Association - protocol in order to read their contents. The values of this option are bit selectable, meaning that more than one setting may be enabled. Each digit in the five-digit display corresponds to a particular setting. You can use the Up and Down arrow buttons to enable a bit by setting it to **1**, or disabled by setting it to **0**. After setting one digit, the cursor will advance to the next digit to the right. For example,

**Table 20: SIA Option**

Action	Display
Convert comma ',' to forward slash '/'	X0000
Convert BFSK to SIA	OX000
Convert Pulse to SIA	OOX00
Convert SIA account A	OOOX0
Force SIA zone number	OOOOX

The selectable possibilities are listed below:

**Bit0 - Force SIA Zone Number**

The unit will decode SIA alarms sent without zone numbers and add '00' before it is sent to the automation software output.

E.g. [#1234|NriBA] becomes [#1234|NriBA00]

E.g. [#1234|NBA/BH] becomes [#1234|NBA/BH00]

**Bit1 - Convert SIA Account A's**

Any account digits received as an 'A' will be converted to **0**.

E.g. [#A123|NriBA01] becomes [#A123|NriBA01]

**Bit2 - Convert Pulse Formats to SIA**

All Pulse format printer and computer outputs will be converted to SIA, in a two-step conversion process. The automation output will use the protocol ID of 'R'.

First, the type of alarm is determined by Options 30 - 5F, 70.

Second, the type of alarm is mapped to a SIA output as per the table below.

E.g., 12341 becomes 1234 A 1, then [#1234|NBA1]



Values programmed in Options 30 - 5F, 70 elsewhere other than in this table will default to **UAxx** for Undecoded Alarm.

**Table 21: SIA Conversion**

Value	Code	SIA
41	A	BA
42	B	BA
43	C	CL
46	F	FA
48	H	HA
4F	O	OP
4D	M	MA
50	P	PA
52	R	BR
54	T	TA
5C	\	OC
62	b	BR
66	f	FH
68	h	HH
6D	m	MH
70	p	PH
74	t	TH
7C	l	UB

**Bit3 - Convert BFSK format to SIA**

The BFSK outputs will be converted to SIA. The automation output will use the protocol ID of 'R'.

When this bitwise value is set it has precedence over the BFSK RS232 Option A4. The accounts 3/x to 4/x in Option 76 may be used to insert a leading '0' to the account code.

E.g. [#123|NFA1]

**Bit4 - Convert a comma (',') to a forward slash ('/')**

When this bitwise value is enabled, any commas will be converted to a forward slash.

E.g. [#1234|NBA1,2,3] becomes [#1234|NBA1/2/3]

**Option 173: Input/Output Sensitivity***Default (13)*

This option serves a dual purpose, in that the DSP input sensitivity and the DSP output level are set. The lower nibble of the option will set the output level; the high nibble will set the input sensitivity of the DSP.

**NOTE: For more information, please contact DSC Technical Support.**

**Option 174: Equivalent Line Number***Default (00)*

This option is used with the receiver number - see **Option 175: Receiver Number on page 59** - for sending signals to the central station automation software. These signals include trouble, alarm, etc. You can use this option to compensate if no DNIS number is being received by the line card.

**Option 175: Receiver Number***Default (01)*

The receiver number is used to send signals to the central station software. Please refer to your central station automation software manuals to determine if there are any special requirements for this number. In addition, check the numbers used for any other receivers in the station to ensure that numbers are not duplicated.

**Option 176: Accounts 3/x - 4/x***Default (00)***Table 22: Accounts 3/x - 4/x**

Value	Description	Example
00	Disabled. If the alarm is reported in 3/1, 3/1 extended, BFSK, 3/2 or 3/8 ACRON formats, a leading space will be placed in front of the 3-digit account codes.	1RRLLlsssssssAAAsXsssY[DC4]
01	If the alarm is reported in 3/1, 3/1 extended, 3/2 or 3/8 ACRON formats, a leading <b>0</b> (zero) will be placed in front of the 3-digit account codes.	1RRLLlsssssss0AAAsXsssY[DC4]
02	Alarms communicated to the computer. If the alarm is reported in 3/1, 3/1 extended, 3/2 or 3/8 ACRON formats, a leading <b>0</b> (zero) will be placed in front of the 3-digit account. In addition, a <b>0</b> (zero) will be placed in front of the 1-digit alarm code for the above formats as well as 4/1 formats.	1RRLLlsssssss0AAAsXss0Y[DC4]
04	If the panel is reported in SIA two leading <b>00</b> (zeros) will be placed in front of the 3-digit account.	SRLLlL[#00AAA Nri0/FH00]
05	If the alarm is reported in 3/1, 3/1 extended, 3/2 BFSK, SIA, 3.8 ACRON formats then a leading <b>0</b> (zero) will be placed in front of the 3-digit account.	
06	If the alarm is reported in 3/1, 3/1 extended, 3/2 BFSK, SIA, 3.8 ACRON formats then a leading <b>0</b> (zero) will be placed in front of the 3-digit account and a <b>0</b> (zero) will be placed in front of the 1-digit alarm code.	

**Option 177: Digit Replace***Default (00)*

Use this option to replace one particular digit with another. It is provided in order to deal with those panels, particularly those working with DTMF, that will send a '0' instead of an 'A'. It also allows the user to smooth operations with the automation software, which will not always accept '0's.

Option 177 works in conjunction with Option 1A2. When Option 1A2 is enabled and Option 177 is programmed with an ASCII value, the receiver will replace or insert an account code digit. Option 1A2 determines whether to replace or insert a digit. To replace a digit set Option 1A2 to 0x, where x is the digit to be replaced. To insert a digit set Option 1A2 to 8x, where x is the digit in the account code; following this digit will appear the inserted digit.

**Example 1 (Replacing)**

Option 177 is set to **41** and Option 1A2 is set to **01**; the account code is 9876 1RRLLLsssss9876sXssYZ.

The receiver will remove the first digit (Option 1A2 = **01**) of the account code ('9' in this example) and replace it with the ASCII value of 41, which is an 'A'.

New output: **1RRLLLsssssA876sXssYZ**

**Example 2 (Inserting)**

Option 177 is set to 2D and Option 1A2 is set to 82; the account code is 9876 1RRLLLsssss9876sXssYZ.

The receiver will insert the ASCII value of Option 177 - in this case the ASCII value of 2D (2D is a '-') - into position two (Option 1A2 = 82) and the account code will shift to the left. The account code of 9876 will be converted to 9-876, as indicated below.

New output: **1RRLLLsssss9-876sXssYZ**

Option 177 will not affect SIA.

**Option 178: Maximum Inter-Digit***Default (00)*

It is possible that established diallers may have some difficulty in communicating with the line cards. Use this option to overcome this difficulty, should it occur. When programmed as **00**, the inter-digit time is determined by the Baud rate of the format being used; all other values are in 100 msec increments.

00 - Automatically determine inter-digit by baud rate (Default)

01 - 100 msec

02 - 200 msec

... ..

0A - 1000 msec

**Option 179: Maximum Inter-Burst***Default (00)*

It is possible that established diallers may have some difficulty in communicating with the line cards. Use this option to overcome this difficulty, should it occur. When programmed as **00**, the inter-burst has a time of 100 msec; all other values are in 10 msec increments.

00 - 100 msec (default)

01 - 10 msec

02 - 20 msec... etc.

**Option 17A: Four- and Five-Digit Account Codes To Activate Two-Way Radio***Default (00)*

Use this option to determine which four- and five-digit account codes will be able to activate the 2-way audio feature. Use Option 17A to set the first two digits of a desired account code.

For example:

To allow all account codes between 1000 and 2FFF to activate the 2-way audio function, program Option 17A as **12**.

To allow all account codes between 3000 and 6FFF to activate the 2-way audio function, program Option 17A as **36**.

To disable the 2-way audio function, program Option 17A as **00**.

**NOTE: Either Option 104: Audio Time or Option 111: Hook Flash must be enabled to activate the two-way audio feature of the line card.**

**NOTE: Option 17A may be used with any of the formats supported by the receiver.**

**Option 17B: Three-Digit Account Codes To Activate Two-Way Radio***Default (00)*

Use this option to determine which 3-digit account codes will be able to activate the 2-way audio feature. Use Option 17B to set the first three digits of a desired account code.

For example:

To allow all 3-digits account codes between 200 and 3FF to activate the 2-way audio function, program Option 17B as **23**.

To allow all 3-digit account codes between 300 and 6FF to activate the 2-way audio function, program Option 17B as **36**.

**NOTE: Either Option 104: Audio Time or Option 111: Hook Flash must be enabled to activate the two-way audio feature of the line card.**

**NOTE: Option 17B may be used with any 3-digit account code formats supported by the receiver.**

**Option 17C: Audio Alarm Code Range***Default ()*

Use this option to determine the range of alarm codes able to activate the 2-way audio function.

For Example:

The receiver can initiate audio by using Options 17A and 17B, Option 17C, or both.

If all alarm codes beginning with 6, 7, and 8 are to activate 2-way audio, program Option 17C as **68**. Option 17C may be used with 10 to 40 Baud formats, DTMF 4/1, 4/2, 4/3 formats, and Contact ID.

You can set Option 17C as **00** to disable this function.

Example: 4/2 format with account code 1234, alarm code 2 on zone 3. (1234-23)

**Table 23: Audio Alarm Code Range**

Option 7A	Option 7C	Switch	Reason to Audio
0-0	1-2	Yes	Alarm code 2 falls within the code range 1-2.
1-1	0-0	Yes	Account code 1234 falls within the range 1-1.
2-3	0-0	No	Account code 1234 falls outside the range 2-3.
0-0	3-4	No	Alarm code 2 falls outside the range 3-4.
1-2	3-4	No	Both option values are valid and alarm code 2 falls outside the range 3-4.
3-5	1-3	No	Both option values are valid and account code 1234 falls outside the range 3-5.
1-4	1-5	Yes	Alarm code 2 falls within the code range 1-5, account code 1234 falls within the range 1-4.

**Option 17D: Audio Zone Code***Default (00)*

Use this option to determine the range of zone codes that will activate audio. The first digit is the lowest code that will activate radio; the second digit indicates the highest zone that will activate audio.

Option 17D can be used with the following formats:

- 10 to 40 Baud formats, DTMF 4/1, 4/2, and 4/3 formats.

**Option 17E: Audio RS-232***Default (00)*

Use this option to set the code to be sent to the automation software indicating that two-way audio has been initiated. If this option is set to **00** there will be no audio-initiated message sent to the automation output. If set to **01**, the automation message for audio will be generated with protocol ID **S**. If set to **02**, the automation message will be generated with protocol ID **0**.

00 - No Automation Output

01 - Send SRLLLL[#AAAA[NLFssoo]][DC4]

02 - Send 0RRLLL[#AAAA[NLFssoo]][DC4]

**Option 17F: Audio Format***Default (00)*

Use this option to enable and disable audio for selected formats. A value of **1** in the formats bit position will enable audio. A value of **0** in the formats bit position will disable audio.

Bit 0 - Standard 3-digit pulse and DTMF formats

Bit 1 - Standard 4- and 5-digit pulse formats

Bit 2 - Standard DTMF formats

Bit 3 - Contact ID format

Bit 4 - SIA format  
 Bit 5 - Modem II format  
 Bit 6 - ITI format  
 Bit 7 - Westec format

For example, to enable audio to work only with 3-digit and SIA formats, Option 17F must be set as **11** hexadecimal; this enables bit 0 and bit 4.

### Option 180: Kiss-off to Hang-up

*Default (1F)*

You can use this option to determine the delay between the Kiss-off (acknowledgement of the receipt of data) and the release of the line. The hexadecimal value set in this option will first be converted to decimal, then multiplied by 100 milliseconds to generate the delay.

For example:

Option 180 = 0A hexadecimal = 10 decimal \* 100 msec = 1000 msec = 1 second delay

Option 180 = 1F hexadecimal = 31 decimal \* 100 msec = 3100 msec = 3.1 second delay

Option 180 = 28 hexadecimal = 40 decimal \* 100 msec = 4000 msec = 4 second delay

**NOTE: This option applies only to the following formats: Pulse, DTMF, SKFSK, Robofon.**

### Options 181 - 188: Handshake Selection

*Defaults (see table below)*

**Table 24: Defaults**

Option Number	Default Value
181	23
182	14
183	2D
184	0C
185	0E
186	0B
187	00
188	00

The SG-System I is a multi-format receiver capable of sending several handshakes in the same general time to a dialer or panel. You may need to determine in which order handshakes are sent. Referring to the two tables below - General Handshakes and Specialty Handshakes - program Options 181 - 188 according to your application's requirements.

**NOTE: If Option 2D: AHS is enabled, the AHS handshake will be sent before the handshakes programmed here in Options 181 - 188.**

**Table 25: General Handshakes**

Hexadecimal Value	Description
00	No handshake
0B	Modem II handshake
0C	SIA FSK handshake
0E	ITI and Modem IIE handshake
1A	Robofon handshake
1B	CESA handshake
1C	Outel handshake
1D	Single Dual Tone handshake 1400 Hz/100 msec pause and 2300 Hz/100 msec tone with a kiss off of 1400 Hz
1E	Scantronics Dual Tone
1F	Vonk (no handshake)
2D	Double dual-tone handshake 1400 Hz/100 msec pause and 2300 Hz/100 msec tone with a kiss off of 1400 Hz
3B	Scancom - single dual-tone handshake 1600 Hz/100 msec pause and 2000 Hz/100 msec tone with a kiss off of 1600 Hz
3C	Scancom - single dual-tone handshake 2300 Hz/100 msec pause and 1400 Hz/100 msec tone with a kiss off of 1400 Hz
8D	Single tone - DTMF handshake/kiss-off
EC	SURTEC handshake
FB	CFSK full duplex handshake
FF	Perform inter-handshake time, no tone/frequency sent

All other frequencies can be programmed using the first two digits to represent the third and fourth decimal places (01 - 29).

**Common Examples:**

10 - 1000 Hz / 14 - 1400 Hz / 16 - 1600 Hz / 18 - 1800 Hz / 23 - 2300 Hz

**Table 26: Specialty Handshakes**

Hexadecimal Value	Description
3D	Single dual-tone handshake, DTMF buffering.
4D	Double dual-tone handshake, DTMF buffering.
5D	Single dual-tone handshake, maximum of 16 digits of DTMF, 1400 Hz/100 msec, 100 msec pause and 2300 Hz/100 msec tone with a kiss-off of 1400 Hz.
6D	Single dual-tone handshake, enable Fast DTMF receive mode. 1400 Hz/100 msec, 100 msec pause and 2300 Hz/100 msec tone with a kiss-off of 1400 Hz.
7D	Double dual-tone handshake, enable Fast DTMF receive mode. 1400 Hz/100 msec, 100 msec pause and 2300 Hz/100 msec tone with a kiss-off of 1400 Hz.
98	Do not perform AHS for this ANI number.
99	Immediate hangup, AHS has blocked it.
BE	1400 Hz BFSK only, no pulse.
BF	2300 Hz BFSK only, no pulse.
FB	Full duplex CFSK.
FC	Full duplex SIA.
FE	ITI handshake, Modem IIE filter.

**Additional Notes:**

When using the Vonk Handshake (1F), it is recommended that you program this option first (Option 181).

When using both Outel (1C) and CESA (1B), it is recommended that the Outel be programmed ahead in the handshake order.



**Options 189 - 190: Handshake and Kiss-off Duration***Default (00)*

Some control panels require handshakes of varying duration. Use Options 189 - 190 to make those adjustments accordingly. Each unit is measured in increments of 100 msec, from a minimum of 100 msec to a maximum of 8.1sec.

**Table 27: Handshake/Kiss-off Duration**

Hexadecimal Value	Duration (in msec)
00	1 second
01	100 msec
02	200 msec
03	300 msec
04	400 msec
0A	1 second
0C	1.2 seconds
Etc.	Etc.

DSC does not recommend programmed handshake/kiss-off durations of greater than 1.5 seconds, as these may not be tolerated by the alarm panel. Durations greater than 1.5 seconds may be necessary for special applications, but any duration greater than 8.1 seconds will not be accurate and may not match the programmed duration.

**NOTE:** *These options will only affect steady tones handshakes.*

**Option 191: Inter-Handshake Duration***Default (00)*

The default value for this option will force the SG-System I to wait for four seconds before sending the next handshake, assuming that no acknowledgement signals were received. When working with a particularly fast panel(s), you can program this option with a lower value, saving time and telephone line costs. When working with a slower panel, however, you can program this option with a greater value - up to a maximum of nine seconds - to ensure that sufficient time is allotted to receive an acknowledgement.

**Table 28: Inter-Handshake Duration**

Value	Length (sec)
00	four-second interval
01	one-second interval
02	two-second interval
03	three-second interval

**Table 28: Inter-Handshake Duration**

Value	Length (sec)
04	four-second interval
05	five-second interval
06	six-second interval
07	seven-second interval
08	eight-second interval
09	nine-second interval

**Option 192: Pulse Mode***Default (00)*

00 - Standard Pulse Detection

01 - 50 Baud Pulse Detection

02 - Forced (AAA) Pulse Detection, meaning that only PULSE is detected.

8x - When this bit is enabled it acts as a minimum burst rejection option ,where x can can range from 1 to F (1msec to 15msec).

**Option 193: Minimum Audio Tone***Default (00)*

Use this option for two-way audio tone detection from specific audio panels. Leave this option as per the default value, unless otherwise instructed by DSC Technical Support.

**Option 194: Account Digit Stripping***Default (00)*

There will be circumstances under which output from the SG-System I will not be correctly read by a particular version of automation software, most likely an older version. Using Option 194 you can remove those characteristics from the output - e.g. padded zeroes, filler data - to ensure that this problem is avoided. The various approaches available to format account codes are detailed below.

**To Disable Option 194 - Value 00**To disable Option 94, set the value to **00**.**To Strip an Account Code of an 'F' - Value 01**

Standard 4/2 format Output:

1RRLLlsssssAAAAsXssYZ

When Option 194 is set to **01**, the leading digit of a four-digit panel account code will be stripped if it is an F.

For Example:

Option 194 is set to **01**. The panel account code is F245.104091sssss**F**245sXssYZ

If Option 194 is set to **01** the 'F' will be replaced by a space.  
104091ssssss245sXssYZ

*This setting will also enable the receiver to decode special pulse extended-extended formats. Please see below.*

#### **Details on special pulse extended formats:**

Option 194 is set to **01**. If any of the the reporting code digits are an 'A', they will be reported on the computer and printer as an A instead of as an **0**.

#### **4 digits:**

If two rounds match

- decode the 4-digit ADT pulse extended format:

- 26AC x2 > KO (last digit must be a 'C')
- CCC2 x2 > KO (first 3 digits must be 'C')
- 26AF x2 > KO (last digit must be an 'F')
- FFF2 x2 > KO (first 3 digits must be 'C')

-----

- 26AC2F2

-otherwise decode as 3-1 extended or normal 3-1, and if the first digit is an 'F' it is stripped off.

#### **5 digits:**

If the checksum is good

-decode the 5 digit ADT pulse extended format in the form of:

- 26ACF > KO (second last digit must be a 'C')
- CCC27 > KO (first 3 digits must be 'C')
- 26AFC > KO (second last digit must be an 'F')
- FFF2D > KO (first 3 digits must be 'C')

-----

- 26AC2F2

-otherwise decode as 3-1 extended or normal 3-1, and if the first digit is an 'F' it is stripped off.

-otherwise do normal decoding based on options (4-1, 4-1 extended, 3-1 checksum, 3-2) and if the first digit is an 'F' it is stripped off.

#### **6 digits:**

If two rounds match

-decode the 6 digit ADT pulse extended format in the form of:

- F1231F
- F1231F > KO (last two digits must be '1F' to '8F')
- F12301
- F12301 > KO (last two digits must be '01' to '06')
- F123B2
- F123B2 > KO (last two digits must be 'B0' to 'BF')

-----

- 1231F01B2

-otherwise decode as 4-2.

#### **To Strip an Account Code of a '0' - Value 02**

When Option 194 is set to **02**, the leading digit of any account code greater than four digits will be stripped if it is a zero.

Option 194 will work with the following formats:

- Standard Pulse and DTMF(3/x, 4/x and Extended)
- FBI
- Ademco Super Fast (4/8/1, 4/8)
- Contact ID

- ITI
- SIA
- Modem II
- SKFSK

For Example:

Option 194 is set to **02**. The panel account code is 0345.

104091ssssss0345sXssYZ

The new output is as follows.

104091ssssss345sXssYZ

### Option 195: Five- and Six-Digit Pulse

*Default (00)*

Use this option to distinguish between various 5-digit and 6-digit formats. The formats 4/1, 3/2 and 3/1 with checksum cannot be distinguished because they contain a total of 5 digits. The formats 4/2 and 5/1 cannot be distinguished because they contain a total of 6 digits.

**Table 29: Five- and Six-Digit Pulse**

Value	Five-Digit Setting	Six-Digit Setting
00	Select 4/1 format	Select 4/2 format
01	Select 3/2 format *NOTE1	Select 4/2 format
02	Select 3/1 checksum format	Select 4/2 format
03	Select 3/1 checksum format special *NOTE2	Select 4/2 format
10	Select 4/1 format	Select 5/1 format *NOTE3
11	Select 3/2 format *NOTE1	Select 5/1 format *NOTE3
12	Select 3/1 checksum format	Select 5/1 format *NOTE3
13	Select 3/1 checksum format special *NOTE2	Select 5/1 format *NOTE3

**NOTE: 1** The printer messages for the 3/2 format are the same as those used for the 4/2 format.

**NOTE: 2** This selects 3/1 checksum for 40 baud panels only, responding on the 2300Hz handshake. For all other panels, this will be decoded as 4-1.

**NOTE: 3** The printer messages for the 5/1 format are the same as those used for the 4/1 format.

Automation output:

1RRLlLlssssssAAAAsEsssZ[DC4] (4/1)

1RRLlLlssssssAAAAsEssYZ[DC4] (3/2)

1RRLlLlssssssAAAAsEsssZ[DC4] (3/1)

1RRLlLlssssssAAAAsEsssZ[DC4] (5/1)

Printer outputs:

RR-LLL-AAAA-Z-Message (4/1)

RR-LLL-AAA-YZ-Message (3/2)  
 RR-LLL-AAA-Z-Message (3/1)  
 RR-LLL-AAAAA-Z-Message (5/1)

### **Option 196: 4/1 Extended**

*Default (00)*

You can set this option as **01** to enable combining two round pairs of 4/1 extended format into 4/2 output for reporting to the automation and the printer. For example, with Option 196 enabled, the security control panel can transmit one of the following sets of information:

```
1234 3
1234 3
3333 1
3333 1
```

The SG-System I will interpret this information as *1234 31*.  
 The default value of **00** disables Option 196.

### **Option 197: 4/2 Extended**

*Default (00)*

You can set this option as **01** to combine two round pairs of 4/2 extended format into 4/3 output for reporting to the computer and the printer. Program one of the following:

Example 1:  
 1234 05  
 1234 05  
 0505 16  
 0505 16

The SG-System I will interpret this information as *1234 516*.

Example 2:  
 1234 03  
 1234 03  
 3333 01  
 3333 01

The SG-System I will interpret this information as *1234 301*.

Note that a longer online time is required for this format than for a standard 4/2 format. The default value of **00** disables Option 197.

### **Option 198: 3/1 Extended**

*Default (01)*

You can set this option as **01** to combine two round pairs of 3/1 extended or 3/1 partial extended format into 3/2 output for reporting to the computer and the printer.

For example, with this option enabled, the security control panel can transmit one of the following sets of information:

123 3  
 123 3  
 333 1  
 333 1

The SG-System I will interpret this information as *123 31*.  
 The default value of **01** enables Option 198; when set as **00**, the option is disabled.

### **Option 199: Ademco Express**

*Default (01)*

The Ademco 4/1 Express format may cause conflicts with the Sur-Gard DTMF 4/3 checksum format or FBI Super fast without checksum. You can use this option to inform the line card which of these formats will be used.

00 - Sur-Gard DTMF 4/3 with checksum  
 01 - Ademco 4/1 Express  
 02 - FBI without checksum

### **Option 19A: Error Counter**

*Default (00)*

When you set this option, it will configure the number of consecutive bad pulse rounds before the receiver will automatically hang-up. The default of **00** means this option is disabled and the receiver must wait for the panel to hang-up first.

### **Option 19B: Echo Canceller**

*Default (00)*

You can use this option to suppress the incidence of echo on a telephone line. When Option 19B is enabled and an incoming call is answered, the receiver will generate a 2100 Hz tone with 180 degrees of phase reversal every 450 msec, for a total length of two seconds.

- **00** - Disabled
- **01** - Enabled

### **Option 19C: Acron RS-232**

*Default (01)*

You can set this option as **00** to convert the Acron Super Fast format signal into the standard 3/2 or 4/2 format.

1RRLLLsssssAAAAsXssYY[DC4]

Where 1 = protocol number

RR = receiver number

LLL = line number

sssss = spaces

AAAA = account code

X = Event Code

YY = Zone Number

And to the printer with the library text as

RR-LLL-AAAA-YY-Text

Set this option as **01** to send the Acron Super Fast format to the automation as indicated below:

9RRLLSsssAAAACCCCCCCC[DC4]

Where 9 = protocol number

RR = receiver number

LLL = line number

sss = spaces

AAAA = account code

CCCC = channel 1-4

CCCC = channel 5-8

[DC4] = terminator

And to the printer with no library text as

RR-LLL-AAAA-CCCCCCC

### Option 19D: Modem II RS-232

*Default (01)*

In order for the SG-System I to receive the Modem II formats, two of the handshakes should be programmed 0B or 0E. The Modem II RS-232 option controls how the receiver will output alarms to the automation. This option is a bit selectable option, meaning more than one bit may be enabled.

Bit 0: OFF select protocol: 1RRLLSsssAAAAXYYYYY[DC4].

ON select protocol: 6RRLLSsssAAAAXYYYYY[DC4].

Bit 1: OFF Do not convert to SIA protocol.

ON convert Modem II to SIA protocol: SRLLL[#AAAA|EYZZZ][DC4].

Bit 2: OFF Do not convert to SIA with Modem II ASCII text blocks.

ON Convert to SIA protocol with Modem II ASCII text blocks as

SRLLL[#AAAA|EYZZZ][DC4] and

RRLLL[#AAAA|A...][DC4].

Bit 3: OFF Only decode the first 4 digits of Modem II account codes even if more than four are received.

ON Decode up to 10 digits of Modem II account codes.

Use the default value of **0x01** to format the output with 6RRLL protocol, meaning that it does not convert to SIA, does not process Modem II text blocks, and only decodes the first 4 digits of Modem II account codes.

**NOTE: The lowest bit will also affect the BFSK format decoding.**

**NOTE: Ensure that the automation software supports settings 02 and 06 if the SIA protocol is desired.**

### Option 19E: Scantronics Select

*Default (00)*

You can set this option as **00** to decode 14-Digit DTMF as Scantronics 4-8-1 with Checksum.

You can set this option as **01** to decode 14-Digit DTMF as Scantronics 5-8-1.

### Option 19F: Ademco High Speed RS-232

*Default (01)*

You can set this option as **00** to convert the High Speed format signal into 4-2 format automation:

1RRLLSsssAAAAsXssYY[DC4]

printer: RR-LLL-AAAA-YY-Alarm

You can set this option as **01** to leave the Ademco High Speed fully coded, and the received data is passed to the outputs.

automation: 8RRLLLAAAAsCCCCsCCCCsC[DC4]

printer: RR-LLL-AAAA--cccccccc

Where 8 = protocol number

RR = receiver number

LLL = line number

AAAA = account code

CCCC = channel 1-4

s = space

CCCC = channel 5-8

s = space

C = Channel 9

[DC4] terminator

On the SG-System I this option also controls the Scantronics formats:

2-8-1,5-8-1,6-8-1 (9-digit channels) and 2-16-1,3-16-1,4-16-1,5-16-1,6-16-1 (17-digit channels).

Refer to Option AO (11- and 12-digit DTMF) for configuring conflicting formats.

When this option is programmed as **00**, the SG-System I will convert the outputs in the corresponding 2-2,3-2,4-2,5-2 format:

automation: 1RRLLssssAAAAAAsXssYY[DC4]

printer: RR-LLL-AAAAAA-YY-Alarm

When this option is programmed as **01** the Scantronics formats will not be decoded and the received data is passed to the outputs.

automation:

8RRLLLAAAAAAsCCCCsCCCCsC[DC4] (9-digit channels)

8RRLLLAAAAAAsCCCCsCCCCsCCCCsCCCCsC[DC4] (17-digit channels)

printer:

RR-LLL-AAAAAA--cccccccc (9-digit channels)

RR-LLL-AAAAAA--cccccccccccccccc (17-digit channels)

The above examples are shown with 6-digit accounts; for accounts less than this leading digits are not sent. For example 2-8-1 will be output as:

8RRLLLAAscccccccc[DC4]

RR-LLL-AA--cccccccc

### Option 1A0: 11-/12-Digit DTMF (Acron, Scantronics, or Scancom 433)

*Default (00)*

You can set this option as **00** to decode an 11- or 12-digit DTMF in ACRON format.

You can set this option as **01** to decode an 11- or 12-digit DTMF in SCANTRONICS format.

You can set this option as **02** to decode an 11- or 12-digit DTMF in Scancom 433 format.

Incoming Format	Decoded Format
00 11-digit DTMF	Acron 3-8
00 12-digit DTMF	Acron 4-8
01 11-digit DTMF	Scantronics 2-8-1
01 12-digit DTMF	Scantronics 3-8-1
02 12-digit DTMF	Scancom 433 4-3-3-FF



**Option 1A1: FBI RS-232***Default (01)*

You can use this option to enable your computer for FBI Super Fast protocol.

- **00** - Disabled
- **01** - Enabled

When enabled, the computer output will be as shown below:

**JRLLLLsssssAAAATZZEss[DC4]**

Refer to the table below for an explanation of the computer output:

**Table 30: FBI Super Fast Protocol**

Output segment	Description
J	FBI protocol identifier
RR	Receiver number
LLL	Line number
s	Spaces
AAAA	Account code
T	Zone type
ZZ	Zone number, in hexadecimal
E	Event code
If E = 0 and T = 0	Listen in

**Option 1A2: Digit Replace***Default (00)*

Option 177 works in conjunction with Option 1A2. When Option 1A2 is enabled, and Option 177 is programmed with an ASCII value, the receiver will replace or insert an account code digit. Option 1A2 determines how to replace or insert a digit.

To replace a digit, set Option 1A2 to 0x where x is the digit to be replaced.

To insert a digit, set Option 1A2 to 8x where x is the digit in the account code, after which will be the inserted digit.

**Option 1A3: D6500 RS232***Default (00)*

You can use this option to strip hexadecimal digits from the automation software output. The line card will emulate the Radionics 6500 RS-232 protocol on pulse formats for Ademco Express and Varitech only.

**Option 1A3 is set to 01**

The hexadecimal digit will be stripped for 1-digit reporting codes, including Varitech 4/1.

Example 1: Code 1

Computer output: **104091sssssss022sAsss1**

Example 2: Code B

Computer output: **104091sssssss022sOssss**

**Option 1A3 is set to 02**

The hexadecimal digit will be stripped for 2-digit reporting codes, including Varitech 4/2.

Example 1: Code 21

Computer output: **104091sssssss022sAss21**

Example 2: Code B1

Computer output: **104091sssssss022sOss1**

**Option 1A3 is set to 03**

The hexadecimal digit will be stripped for 1- and 2-digit reporting codes, including Varitech.

**Option 1A3 is set to 04**

The hexadecimal digit will be stripped for BFSK.

Example 1: Code 21

Computer output: **604091sssssss022sAss21**

Example 2: Code B1

Computer output: **604091sssssss022sOss1**

**NOTE: This option will only work if Option 1A4 is set to 01.**

**Option 1A3 is set to 05**

The hexadecimal digit will be stripped for 1-digit reporting and BFSK.

**Option 1A3 is set to 06**

The hexadecimal digit will be stripped for 2-digit reporting and BFSK.

**Option 1A3 set to 07**

The hexadecimal digit will be stripped for 1-digit, 2-digit, and BFSK.

**Option 1A3 set to 0F**

The hexadecimal digit will be stripped for 1-digit, 2-digit, BFSK, and Ademco Express (4-1, 4-2).

**NOTE: Option 170 must be left as an individual event code when enabling Option 1A3.**

**Option 1A4: BFSK RS-232**

*Default (00)*

You can set this option as **00** to report the BFSK format as Radionics 6500 BFSK mode to the computer; the protocol identifier will be the numeral 6.

Example 1: Code 21

Computer Output: 604091 022sAss1

Example 2: Code B1

Computer Output: 604091 022sOss1

You can set this option as **01** to report the BFSK as a standard 3/1 extended format; the protocol identifier will also be changed from 6 to 1.

Example 1: Code 21  
 Computer Output: 104091 022sAss21

Example 2: Code B1  
 Computer Output: 104091 022sOssB1

**Option 1A5: Sescoa Super Speed**  
 Default (01)

**Table 31: Sescoa Super Speed**

Setting	Sescoa Super Speed	4/2/checksum	4/2/checksum failed double-round kissoff	Decode Sescoa as per DRL2A
00	Disabled	Enabled	Enabled	No
01	Enabled	Disabled	Disabled	No
02	Enabled	Disabled	Disabled	Yes
03	Disabled	Enabled	Disabled	No

**Option 1A6: ITI Adjust**  
 Default (00)

You can set this option to **01** to convert the ITI account codes to four digits by stripping the last digit. For example, a panel account of 23459 will become account 2345. If the leading digit of the panel account is a 0, then it will be stripped and replaced with a space. For example, if 02349 is sent the receiver will output 234.

**Option 1A7: Silent Knight FSK2 RS-232**  
 Default (00)

Use this option to provide two possible outputs to the computer for the Silent Knight FSK2 format.

[A7] = 00 SKFSK disabled  
 [A7] = 01 SKFSK enabled for:  
     SKFSK1  
     ERRLsssssAAAAYYssss[DC4]  
     SKFSK2 Protocol #2  
     CRRLssssAAAAAYYZss[DC4]  
 [A7] = 02 SKFSK enabled for:  
     SKFSK1  
     ERRLsssssAAAAYYssss[DC4]  
     SKFSK2 Protocol #2  
     FRRLssssAAAAAYYZss[DC4]

**Option 1A8-1AF: Dial-Out Number for Two-Way Audio Transfer***Default (00)*

You can use these eight options to provide a dial-out number if the user wishes to transfer a call to another extension. Up to 16 digits may be programmed, including any 'Feature Command' digits. The values in these options will be sent as DTMF tones on the phone line after the following sequence takes place:

1. The SG-System I has recognized the current call as a 2-way audio account and alarm code.
2. The calling control panel has finished sending its alarms and switched into 2-way audio mode.
3. The channel will perform a Hook-flash with the time value as set in Option 11, and then start to dial the programmed digits.

Options A8-AF must be programmed in the following manner: Digits 1-9 are programmed as the numbers 1-9. The digit **A** must be programmed if a zero is needed anywhere in the dial string, as the digit zero is used to indicate to the line card that there are no more digits to dial. If an asterisk (\*) is required, (e.g. \*70, the transfer command in some PBX/PABX switches) program a **B**. Similarly, if a # is needed, program a **C**. To get the line card to wait for three seconds in a dial string, program a **D**.

**Table 32: Dial-Out Number for Two-Way Audio Transfer**

DTMF Digit Sent	DTMF Digit Received
0	End of dialling string
1	1
2	2
3	3
4	4
5	5
6	6
7	7
8	8
9	9
A	0
B	*
C	C
D	Three-second pause
E	E
F	F

For example, to transfer a two-way audio call to Ext. 51386, with a three-second pause between the transfer command and dialing, Options A8-AF would be programmed as the following:

A8 = B7  
A9 = AD

AA = 51  
 AB = 38  
 AC = 60  
 AD = 00  
 AE = 00  
 AF = 00

### **Option 1B0: CCITT Audio Format Enable Bits**

*Default (00)*

This option is similar to Option 7F. Use this option to enable and disable audio for the selected CCITT formats. A **1** in the formats bit position will enable the format for audio. An **0** in the formats bit position will disable audio for the format.

Bit 0 Robofon Format  
 Bit 1 VONK Format  
 Bit 2 Stratel Format  
 Bit 3 CESA FOrmat  
 Bit 4 Telnot format  
 Bit 5 Outel format  
 Bit 6 Not used  
 Bit 7 Not used

For example, to enable audio to work only for Robofon and Telnot formats, Option 1B0 must be programmed as **11** hexadecimal. This enables bit 0 and bit 4.

### **Option 1B1: DMP Area BIN or DEC Option**

*Default (00)*

This option is similar to the DMP receiver.

00 = Area is sent to the automation in BINARY  
 01 = Area is sent to the automation in DECIMAL

The printer outputs remain unchanged.

Examples: Area is sent to the line card as C0

BINARY setting:

Automation:

P01001 20999 L0480TIMAREA 1

P01001 20999 L0440TIMAREA 2

Printer:

00-01-001-20999--Close USR:04 AREA1 TIMAREA 1

00-01-001-20999--Close USR:04 AREA2 TIMAREA 2

DECIMAL setting:

Automation:

P01001 20999 L0401TIMAREA 1

P01001 20999 L0402TIMAREA 2

Printer:

00-01-001-20999--Close USR:04 AREA1 TIMAREA 1

00-01-001-20999--Close USR:04 AREA2 TIMAREA 2

**Option 1B2: Format Disable***Default (00)*

You can use this option to avoid unwelcome VoIP issues by forcing your unit to receive only those DTMF formats you have stipulated. In this way your receiver will not confuse unwanted DTMF formats for those you require. This option is bit-oriented, and so more than one value may be selected. Each value will disable the decoding of the accompanying DTMF formats.

**Table 33: DTMF Format Disable**

Bit	Description
0	15 digits DTMF format
1	13 digits DTMF format
2	8 digits DTMF format
3	22 digits DTMF format
4	11 digits DTMF format
5	12 digits DTMF format
6	23 digits DTMF format
7	14 digits DTMF format

The values of this option are bit selectable, meaning that more than one setting may be enabled. Each digit in the eight-digit display corresponds to a particular setting. You can use the Up and Down arrow buttons to enable a bit by setting it to **1**, or disabled by setting it to **0**. After setting one digit, the cursor will advance to the next digit to the right. For example,

**Table 34: DTMF Format Disable Programming**

DTMF	Display
14-digit DTMF	X0000000
23-digit DTMF	OX000000
12-digit DTMF	OOX00000
11-digit DTMF	OOOX0000
22-digit DTMF	OOOOX000
8-digit DTMF	OOOOOXOO
13-digit DTMF	OOOOOOXO
15-digit DTMF	OOOOOOOX



# 6 Options: IP

---

## In This Chapter...

[IP Option Index on page 81](#)

[Steps required to access an option and change its setting or value on page 81](#)

[IP Options on page 81](#)

## IP Option Index

<b>Option 30D: Alarm Port Number on page 81</b>	<b>Option 31E: Mask Unknown Account on page 83</b>
<b>Option 30F: Receiver Number on page 82</b>	<b>Option 31F: Mask Supervised Acc Exceeded on page 84</b>
<b>Option 313: Transmitter Failure Debounce Time on page 82</b>	<b>Option 320: Mask Transmitter Deleted on page 84</b>
<b>Option 315: Transmitter Restoral Debounce Time on page 82</b>	<b>Option 33A: Account Port on page 84</b>
<b>Option 319: Mask Transmitter Restoral on page 82</b>	<b>Option 340: Account Password on page 84</b>
<b>Option 31A: Mask Transmitter Failure on page 82</b>	<b>Option 344: DNIS Replacement of RRLLL on page 84</b>
<b>Option 31B: Mask Transmitter Swap on page 83</b>	<b>Option 346: Account Digit Strip on page 85</b>
<b>Option 31C: Mask Transmitter Unencrypted on page 83</b>	<b>Option 347: SIM ID Output on page 85</b>
<b>Option 31D: Mask Invalid Report on page 83</b>	

## Steps required to access an option and change its setting or value

The steps required to access an option and change its setting or value are very nearly uniform from option to option. The procedure detailed below will satisfy the majority of options. Those it does not will accept close, intuitive variations of it. Please refer to the steps below when programming system options.

To change an option's setting or value, take the following steps:

1. Turn on the SG-System I.
2. Use the Up and Down buttons to select the user. *User '0' has full administrative powers; all other users may only review system settings, in addition to changing the time and date.*
3. Press the Enter button. This initiates the password sequence, placing a flashing cursor underneath the first digit of the four-digit password.
4. Use the Up and Down buttons to select the appropriate value. Press the Enter button. The cursor will advance to the next digit.
5. Repeat Step 4 for all four digits. If the password you have entered is correct, you now have access to SG-System I. If not, re-enter your password.
6. **View or Change Options** appears on the LCD. Press the Enter button.
7. Use the Up and Down buttons to locate which section of options is valid for your configuration of SG-System I: **CPM Options / Channel-1 Options / Channel-2 Options / Channel-IP Options / Exit Menu.**
8. Press the Enter button. The options applicable to your system are to available for you to access.
9. Navigate to Option XXX. Press the Enter button. The current value is displayed on the LCD.
10. Press the Enter button. The value may now be changed.
11. Use the Up or Down buttons to scroll to the desired value.
12. Having made a selection, press the Enter button.
13. The LCD will prompt you to accept (Y?) or to decline (N?) your changes.
14. Use the Up and Down buttons to select your response. Press the Enter button.
15. Your changes have been saved.

## IP Options

### Option 30D: Alarm Port Number

*Default (3061)*

Use this option to set the Alarm Port connection number for your receiver. While the default value will suffice in environments involving just one receiver, Option 30D can be used to differentiate receivers in a complex, multiple receiver environment. If this option is changed, IP communication modules connected to the SG-System I must be programmed with the new receiver number. Communications connected to the receiver will send their signals to this port.

**NOTE: The SG-System I must be restarted for these changes to take effect.**



**Option 30F: Receiver Number***Default (01)*

The receiver number is used for sending signals to the central station software. Refer to the manuals for any central station automation software being used to determine if there are any special requirements for this number. Also, ensure that there are no duplicate receiver numbers used.

**Option 310: Line Card Number***Default (03)*

Use this option to provide each SG-System I line card with an identification code. A range of hexadecimal numbers from **01 - FE** can be programmed in this option to identify your line cards.

**Option 313: Transmitter Failure Debounce Time***Default (120)*

The time, in seconds, for which a transmitter configured in supervised mode must be absent before a transmitter failure condition is reported. Valid entries range from **30 - 65535** seconds.

**NOTE: T-Link Absent Time should not be less than 90 seconds. For ULC Installations, Security Level A4, this option should be programmed as 90 seconds. For UL Installations, this option should be programmed as 180 seconds.**

**Option 315: Transmitter Restoral Debounce Time***Default (60)*

The time, in seconds, for which a transmitter must be present before it is registered in the Account Table and the transmitter restoral message is sent. Valid entries range from **30 - 65535** seconds.

**Option 319: Mask Transmitter Restoral***Default (OFF)*

Use this option to enable or disable the reporting of the transmitter restoral condition on the SG-System I receiver. The default value is appropriate in most situations, save those when the transmitter status is expected to fluctuate often due to, for example, system maintenance.

- **OFF** - Condition is reported.
- **ON** - Condition is not reported (masked).

**NOTE: Refer to UL864 Programming Requirements on page 10 if changing the default setting.**

**Option 31A: Mask Transmitter Failure***Default (OFF)*

Use this option to enable or disable the reporting of the transmitter failure condition on the SG-System I receiver. The default value is appropriate in most situations, save those when the transmitter status is expected to fluctuate often due to, for example, system maintenance.

- **OFF** - Condition is reported.
- **ON** - Condition is not reported (masked).

**NOTE: Refer to UL864 Programming Requirements on page 10 if changing the default setting.**

**Option 31B: Mask Transmitter Swap***Default (OFF)*

Use this option to enable or disable the reporting of the T-Link swap condition on the SG-System I receiver. The default value is appropriate in most situations, save those when the transmitter status is expected to fluctuate often due to, for example, system maintenance.

- **OFF** - Condition is reported.
- **ON** - Condition is not reported (masked).

**NOTE:** Refer to *UL864 Programming Requirements on page 10 if changing the default setting.*

**Option 31C: Mask Transmitter Unencrypted***Default (OFF)*

Use this option to enable or disable the reporting of the T-Link sending an unencrypted event when the SG-System I receiver is expecting an encrypted event condition on a SG-DRL3-IP receiver. The default value is appropriate in most situations, save those when a number of unencrypted events are expected to be sent due to, for example, system testing or maintenance.

- **OFF** - Condition is reported.
- **ON** - Condition is not reported (masked).

**NOTE:** Refer to *UL864 Programming Requirements on page 10 if changing the default setting.*

**Option 31D: Mask Invalid Report***Default (OFF)*

Use this option to enable or disable the reporting of the invalid report condition. The SG-System I determines that the signal received is invalid, a bad checksum, or an encryption key mismatch. The default value is appropriate in most situations, save those when a number of invalid reports is expected due to, for example, system maintenance.

- **OFF** - Condition is reported.
- **ON** - Condition is not reported (masked).

**NOTE:** Refer to *UL864 Programming Requirements on page 10 if changing the default setting.*

**Option 31E: Mask Unknown Account***Default (OFF)*

Use this option to enable or disable the reporting of an unknown account report condition when the SG-System I receiver determines that it is from an invalid account (not in the Account table). The default value is appropriate in most situations, save those when a number unknown accounts are expected to be reported due to, for example, system testing or maintenance.

- **OFF** - Condition is reported.
- **ON** - Condition is not reported (masked).

**NOTE:** Refer to *UL864 Programming Requirements on page 10 if changing the default setting.*

**Option 31F: Mask Supervised Acc Exceeded***Default (OFF)*

Use this option to enable or disable reporting if the account table limit is exceeded when a new account tries to connect to a SG-System I that already has a full account table. The default value is appropriate in most situations, save those when the account table limit is expected to be reached due to, for example, system testing or maintenance.

- **OFF** - Condition is reported.
- **ON** - Condition is not reported (masked).

**NOTE:** Refer to *UL864 Programming Requirements on page 10 if changing the default setting.*

**Option 320: Mask Transmitter Deleted***Default (OFF)*

Use this option to enable or disable reporting if a T-Link account is deleted from a table. The default value is appropriate in most situations, save those when multiple deletions are expected to be undertaken due to, for example, system testing or maintenance.

- **OFF** - Condition is reported.
- **ON** - Condition is not reported (masked).

**Option 33A: Account Port***Default (3064) decimal; (0x0BF8) hexadecimal*

Use this option to select a port number on which the SG-System I receiver will communicate with the T-Link Console software for administration of the T-Link Account Table. You should ensure that a unique number is used for this option.

**NOTE:** *The SG-System I must be restarted for these changes to take effect.*

**Option 340: Account Password***Default (CAFE)*

Use this option set a password to restrict access to the receiver account table. In order to retrieve or modify the receiver account table, any application that connects to it must have the same password. You must ensure that these applications and Option 340 share the identical password. Applications that connect to the receiver account table include the following:

- T-Link Console
- SG Receiver Consoles
- Table Loader
- DLS (downloading software)

**Option 344: DNIS Replacement of RRLLL***Default (00)*

Use this option to instruct the SG-System I to output the RRLLL (receiver number and line number), or to replace the output of RRLLL with DNIS from a DSC GSM transmitter, depending on the type of transmitter you have installed on your site. Both values will send the output to the printer and to the automation software.

- **00** - SG-System I will output the RRLLL
- **01** - SG-System I will output the DNIS



The output is explained in the table below.

**Table 36: SIM ID Output**

Character	Description
s	the protocol number
RRLLL	the receiver and line numbers of the line card that received the event
A	the 10-digit account number
S	the SIM number of the transmitter that sent the event





A

Events and  
Messages

---

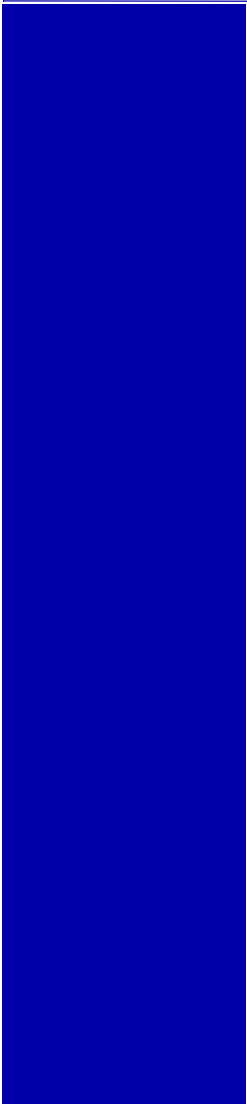

Table 37: Events and Messages

Description/Event	Automation Message	Printer Message
TCP/IP Printer Failure	001000[#0000 NVZ0100]	01-000-0000-NVZ0100-TCP/IP Printer Failed
TCP/IP Printer Restoral	001000[#0000 NVY0100]	01-000-0000-NVY0100-TCP/IP Printer Restored
Parallel Printer Failure	001000[#0000 NVZ0101]	01-000-0000-NVZ0101-Parallel Printer Failed
Parallel Printer Restoral	001000[#0000 NVY0101]	01-000-0000-NVY0101-Parallel Printer Restored
Serial Printer Failure	001000[#0000 NVZ0K102]	01-000-0000-NVZ0102-Serial Printer Failed
Serial Printer Restoral	001000[#0000 NVY0102]	01-000-0000-NVY0102-Serial Printer Restored
USB Printer Failure	001000[#0000 NVZ0103]	01-000-0000-NVZ0103-USB Printer Failed
USB Printer Restoral	001000[#0000 NVY0103]	01-000-0000-NVY0103-USB Printer Restored
SG-TCP/IP Automation Failure	001000[#0000 NNT0100]	01-000-0000-NNT0100-SG-TCP/IP Failed
SG-TCP/IP Automation Restoral	001000[#0000 NNR0100]	01-000-0000-NNR0100-SG-TCP/IP Restored
Serial Automation Failure	001000[#0000 NYC0101]	01-000-0000-NYC0101-SG-SERIAL Failed
Serial Automation Restoral	001000[#0000 NYK0101]	01-000-0000-NYK0101-SG-SERIAL Restored
Switch To Active Mode (Where ## is the slot number 03 - TCP 01 - Serial)	001000[#0000 NSC00##]	01-000-0000-NSC00##-Switching To Active Mode
Switch To Manual Mode	001000[#0000 NSC0000]	01-000-0000-NSC0000-Switching To Manual Mode
Computer Internal communication error Pots Channels	001002[#0000 NRT0101]	01-002-0000--Internal Communication Error (ASCII data output)
Printer Internal communication error Pots Channels	NA	01-002-0000--Internal Communication Error (ASCII data output)
Printer Internal communication error Pots Channels	001002[#0000 NRT0101]	NA
Internal Communication error - POTS Channels	001000[#0000 NYO0101]	01-000-0000-NYO0101-Computer: Inter-Comm Error
Internal communication error IP Channels	001003[#0000 NRT0002]	01-003-0000--Internal Communication Error (ASCII data output)
Computer Internal communication error IP Channels	001003[#0000 NRT0002]	01-003-0000-RT-Computer: Internal Comm. Error
Printer Internal communication error IP Channels	NA	01-003-0000--Internal Communication Error (ASCII data output)



Printer Internal communication error IP Channels	001003[#0000 NRT0002]	01-003-0000-RT-Computer: Internal Comm. Error
Computer Internal Communication error - IP Channels	001000[#0000 NYO0102]	01-000-0000-NYO0102-Computer: Inter-Comm Error
Operator Log in where ## is the operator number logging in (in hex)	001000[#0000 NLB00##]	00/00-SG -01-000-0000-NLB00##-User:0 Local Programming Begins
Operator Log out where ## is the operator number logging in (in hex)	001000[#0000 NLD00##]	01-000-0000-NLD0000-User:## Local Programming Ended
Operator access denied where ## is the operator number logging in (in hex)	001000[#0000 NLX00##]	01-000-0000-NLX00##-User:## Local Programming Denied
SG-SYSTEM I Power Up	001000[#0000 NRR0001]	01-000-0000-NRR0001-SG-System I Power Up
UPS AC Fail (PGM In)	001000[#0000 NAT0102]	01-000-0000-NAT0102-UPS AC Failed
UPS AC Restored	001000[#0000 NAR0102]	01-000-0000-NAR0102-UPS AC Restored
UPS Low Battery Restore	001000[#0000 NYR0102]	01-000-0000-NYR0102-UPS Battery Restored
UPS Low Battery	001000[#0000 NYT0102]	01-000-0000-NYT0102-UPS Battery Low
Console Session Denied	001000[#0000 NRD0001]	01-000-0000-NRD0001-Console Session Denied
Automation Time & Date Failure	001000[#0000 NRU0000]	01-000-0000-NRU0000-Time&Date Update Fail
System Option Change (where XX is the option #, and YY is the new option setting)	001000[#0000 NLS0101]	01-000-0000-NLS0101-Option Change: C0 #XX YY
Channel 1 Option Change (where XX is the option #, and YY is the new option setting)	001000[#0000 NLS0101]	01-000-0000-NLS0101-Option Change: C1 #XX YY
Channel 2 Option Change (where XX is the option #, and YY is the new option setting)	001000[#0000 NLS0101]	01-000-0000-NLS0101-Option Change: C2 #XX YY
Channel IP Option Change (where XX is the option #, and YY is the new option setting)	001000[#0000 NLS0101]	01-000-0000-NLS0101-Option Change: C3 #XX YY
Option change from console where C# is the channel changed (0 = system, 1/2 POTS channels, 3 IP channel)	001000#0000 NLS0101	00/00-SG -01-000-0000-NLS0101-Option Change: C#
Printer Buffer Full (IP Channel)	001003[#0000 NYB0001]	01-003-0000-YB-Printer Buffer Full
Printer Buffer Full (POTS Channel)	001002[#0000 NYB0001]	01-002-0000-YB-Printer Buffer Full

Computer Buffer Full (IP Channel)	001003[#0000 NYB0002]	01-003-0000-YB-Computer Buffer Full
Computer Buffer Full (POTS Channel)	001002[#0000 NYB0002]	01-002-0000-YB-Computer Buffer Full
Checksum Fail	001000[#0000 NYF 0100]	01-001-0000--Checksum Failed
Call was blocked on channel 1 (not answered)	01001[#0000 ABLOCKEDCALL <DNIS> <ANI>	01-001-0000--BLOCKED CALL <DNIS> <ANI>
Call was blocked on channel 2 (not answered)	01002[#0000 ABLOCKEDCALL <DNIS> <ANI>	01-002-0000--BLOCKED CALL <DNIS> <ANI>
Panel attempted to communicate to the linecard but data was not valid.	001001[#0000 NYN0101]	01/01-SG -01-001-0000--INVALID REPORT
Call could not be processed because of bad DNIS structure or no response by the panel - channel 1	001001[#0000 NYC0101]	01-001-0000--COMMUNICATION FAIL
Call could not be processed because of bad DNIS structure or no response by the panel - channel 1	001002[#0000 NYC0101]	01-002-0000--COMMUNICATION FAIL
Phone line trouble channel 1 primary.	001001[#0000 NLT0101]	01-001-0000--PHONE LINE TROUBLE
Phone line restore channel 1 primary.	001001[#0000 NLR0101]	01-001-0000--PHONE LINE RESTORAL
Phone line trouble channel 2 primary.	001002[#0000 NLT0102]	01-002-0000--PHONE LINE TROUBLE
Phone line restore channel 2 primary.	001002[#0000 NLR0101]	01-002-0000--PHONE LINE RESTORAL
Phone line trouble channel 1 backup.	001001[#0000 NLT0101]	01-001-0000--PHONE LINE 2 TROUBLE
Phone line restore channel 1 backup.	001001[#0000 NLR0101]	01-001-0000--PHONE LINE 2 RESTORAL
Phone line trouble channel 2 backup.	001002[#0000 NLT0102]	01-002-0000--PHONE LINE 2 TROUBLE
Phone line restore channel 2 backup.	001002[#0000 NLR0101]	01-002-0000--PHONE LINE 2 RESTORAL
DSP fault channel 1	001001[#0000 NYF0101]	01-001-0000--DSP FAULT
DSP fault channel 2	001002[#0000 NYF0101]	01-002-0000--DSP FAULT
Communication on-line timeout Channel 1	001001[#0000 NYS0101]	01-001-0000--DRL ON-LINE TIMEOUT
Communication on-line timeout Channel 2	001002[#0000 NYS0101]	01-002-0000--DRL ON-LINE TIMEOUT

Two Way Audio Initiated - channel 1 - where XXXX is the account code entering two way communication	001001[#XXXX NLF0101	01-001-XXXX--AUDIO INITIATED
Two Way Audio Initiated - channel 2 - where XXXX is the account code entering two way communication	001002[#XXXX NLF0102	01-002-XXXX--AUDIO INITIATED
Two Way Audio Cancelled - channel 1	N/A	01-001-XXXX--AUDIO CANCELLED
Two Way Audio Cancelled - channel 2	N/A	01-002-XXXX--AUDIO CANCELLED
COLDBOOT was performed by System	001000[#0000 NYE0100]	01-000-0000-NYE0100-Coldboot by LCD/UI
Network Present	001003[#0000 NNR*10.0.0.1*]	01-003-0000-NR-Network Restoral
Network Absent	001003[#0000 NNT*10.0.0.1*]	01-003-0000-NR-Network Failure
Transmitter Restoral (where IP is transmitters IP, and X is the transmitters account)	001003[#XXXXXXXXXX NYK*10.0.0.1*]	01-003-XXXXXXXXXX -YK-*Transmission Restoral 10.0.0.1*
Transmitter Failure (where IP is transmitters IP, and X is the transmitters account)	001003[#XXXXXXXXXX NYC*30.0.0.1*]	01-003-XXXXXXXXXX-YC-*Transmission Failure 10.0.0.1*
Transmitter Swap (where IP is transmitters IP, and X is the transmitters account)	001003[#XXXXXXXXXX NYS*10.0.0.1*]	01-003-XXXXXXXXXX-YS-*Transmitter Swap 10.0.0.1*
Transmitter Unencrypted (where IP is transmitters IP, and X is the transmitters account)	001003[#XXXXXXXXXX NNC*10.0.0.1*]	01-003-XXXXXXXXXX-NC-*Transmitter Unencrypted 10.0.0.1*
Invalid Report (where IP is transmitters IP, and X is the transmitters account)	001003[#XXXXXXXXXX NYN*10.0.0.1*]	01-003-XXXXXXXXXX-YN-*Invalid Report/Possible Compromise Attempt 10.0.0.1*
Possible Compromise Attempt (where IP is transmitters IP, and X is the transmitters account)	001003[#XXXXXXXXXX NPC*10.0.0.1*]	01-003-XXXXXXXXXX-PC-Possible Compromise Attempt

Max Accounts Exceeded (where IP is transmitters IP, and X is the transmitters account)	001003[#XXXXXXXXXX NJO*10.0.0.1*]	01-003-XXXXXXXXXX-JO-*Maximum Accounts Exceeded 10.0.0.1*
Transmitter Deleted (where IP is transmitters IP, and X is the transmitters account)	001003[#XXXXXXXXXX NJX*10.0.0.1*]	01-003-XXXXXXXXXX-JX-*Transmitter Deleted 10.0.0.1*
Unknown Account (where IP is transmitters IP, and X is the transmitters account)	001003[#XXXXXXXXXX NXA*10.0.0.1*]	01-003-XXXXXXXXXX-XA-*Unknown Account 10.0.0.1*
IP Channel has reached 75% capacity of its table	001003[#0000 NJL*192.168.2.184*]	01-003-0000-JL-*Account table 75% full 10.0.0.1*
AHS Database Full	NA	01-000-0000--CPM AHS Database Full
AHS write to memory start	NA	01-000-0000--AHS Flash Start (ACTIVE)
AHS write to memory done	NA	01-000-0000--AHS Flash Done (ACTIVE)
Reset fallback	001000[#0000 NYY0000]	01-000-0000-NYY0000-Reset SG-Fallback Initiated
Console Lead In IP Channel	001003[#0000 NRB*10.0.0.1*]	01-003-0000-RB-Console Account Port Lead In
Console Lead Out IP Channel	001003[#0000 NRS*10.0.0.1*]	01-003-0000-RS-Console Account Port Lead Out
Reset by console	NA	01-000-0000--RESET by Console
Reset by User	NA	01-000-0000--RESET by LCD/UI
License key entered is incorrect	NA	01-000-0000--Invalid License Key
Firmware update has been started via TCP port	NA	FIRMWARE DOWNLOAD INITIATED <TCP>
Firmware update has been started via USB port	NA	FIRMWARE DOWNLOAD INITIATED <USB>
Firmware has been updated to <version>	NA	FIRMWARE UPDATED to vX.XX.XX.XXX
Firmware update has failed	NA	FIRMWARE UPDATE FAILED
IP account table has been set by the console application	NA	01-000-0000--Console SET Account Table
IP account table has been requested by the console application	NA	01-000-0000--Console GET Account Table



# B Ports

---

In This Appendix...

[Parallel Printer Port on page 95](#)

[Serial Printer Port \(COM2\) on page 96](#)

[RS-232 Serial Automation on page 96](#)

[I/O Port on page 97](#)

## Parallel Printer Port

The parallel printer port sends events to the local printer (DB25 Female).

**Note:** Maximum cable length is 1.8m (6ft). Longer cables may impair performance.

**Figure 9: Parallel Printer Port**

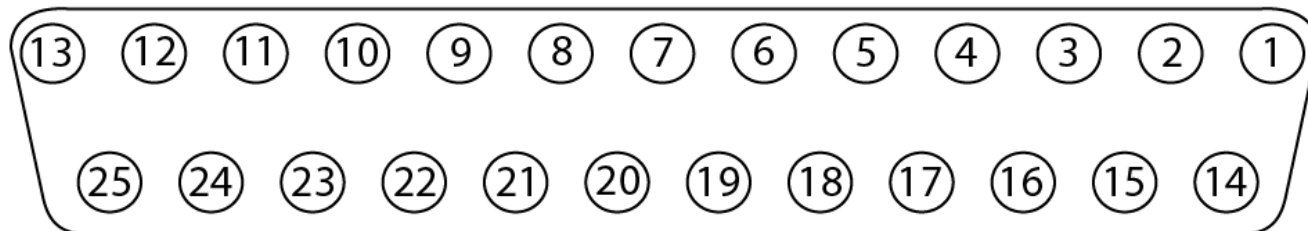

**Table 38: Parallel Printer Port Pinouts**

Pin no (DB25)	Signal name	Direction	Register - bit	Inverted
1	nStrobe	Out	Control-0	Yes
2	Data0	In / Out	Data-0	No
3	Data1	In / Out	Data-1	No
4	Data2	In / Out	Data-2	No
5	Data3	In / Out	Data-3	No
6	Data4	In / Out	Data-4	No
7	Data5	In / Out	Data-5	No
8	Data6	In / Out	Data-6	No
9	Data7	In / Out	Data-7	No
10	nAck	In	Status-6	No
11	Busy	In	Status-7	Yes
12	Paper-out	In	Status-5	No
13	Select	In	Status-4	No
14	Linefeed	Out	Control-1	Yes
15	nHour	In	Status-3	No
16	nInitialize	Out	Control-2	No
17	nSelect-Printer	Out	Control-3	Yes

**Table 38: Parallel Printer Port Pinouts**

Pin no (DB25)	Signal name	Direction	Register - bit	Inverted
18 - 25	Ground	-	-	-

### Serial Printer Port (COM2)

The serial printer port or serial computer port can be connected to a DB9 connector to act as a printer port.

**Figure 10: Printer Port**

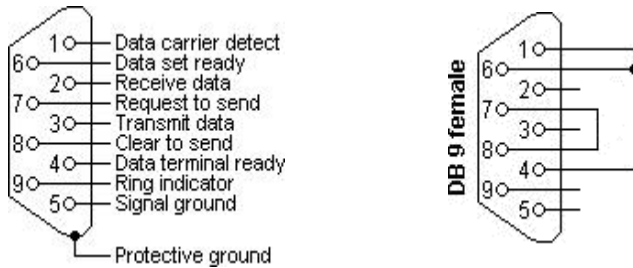

### RS-232 Serial Automation

The serial automation port is used to send automation signals to the automation computer using the Sur-Gard Automation protocol. Only the serial port requires RX, TX, and GRD.

**Table 39: Serial Printer Port**

RJ45 Pin no	Description in relation to SG-System I	DB9 Pin no
1	Not connected	6
2	CTS	8
3	GRD	5
4	TX	3
5	RX	2
6	DCD	1
7	RTS	7
8	Not connected	Not connected

## I/O Port

The I/O interface has access to the list of options below. These connections are located at the back of the unit using a screwless, spring-type terminal. Relays are used for output-switching of the unit. There are three outputs and four inputs on the SG-System I unit.

**Figure 11: I/O Ports**

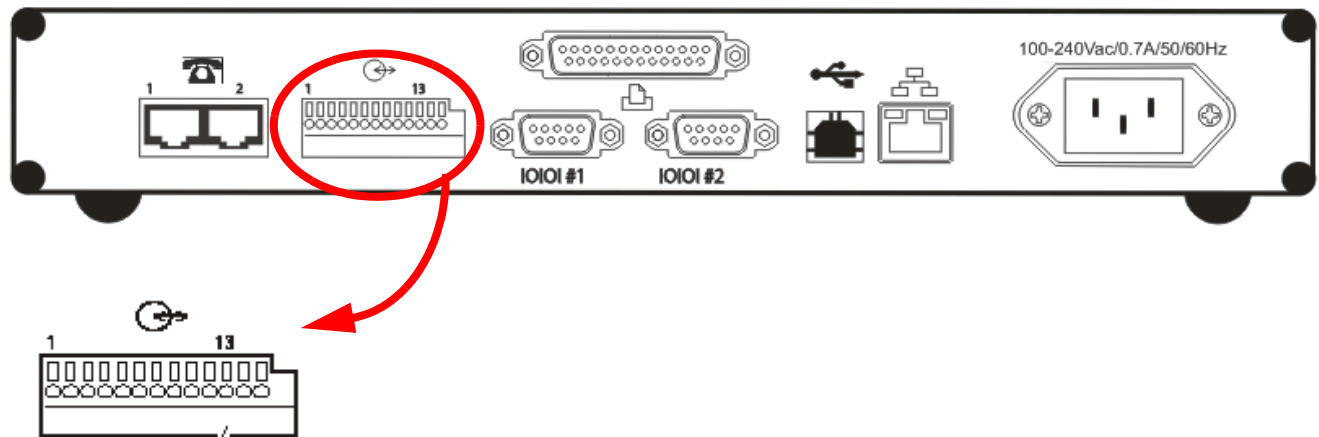

**Note:** Port numbers range from 1 to 13, from left to right.

See item 14 at **Table 3: SG-System I Front and Rear Panel Descriptions** on page 15 for a list and description of the I/O ports.

### I/O Ports - Detailed Descriptions

Input 1 - PIN 1 - UPS AC Failure

- This input - normally closed - is used with backup power supplies that support output activation for the status indication. When this input is activated the SG-System I will indicate a trouble condition for UPS AC Fail. Debounce time on this input is set at 250 msec. Debounce time is not programmable.

Input 2 - PIN 3 - UPS DC Failure

- This input - normally closed - is used with backup power supplies that support output activation for the status indication. When this input is activated the SG-System I will indicate a trouble condition for UPS DC Fail. Debounce time on this input is set at 250 msec. Debounce time is not programmable.

Input 3 - PIN 4 - Remote Ack

- While the unit is in Manual mode, this option is used to provide the user with the means of acknowledging an alarm condition from a remote location. The Remote Ack input will be available any time the front panel Ack button is available. Debounce time on this input is set at 80 msec as will the front panel Ack button. The Remote Ack button must accept depress and release before accepting the next depress.

Input 4 - PIN 6 - Reserved for Future Use



**Output 1 - PIN 7 - Buzzer Follow**

- This output is used to provide the user with the ability to position the receiver in a remote location and continue to be able to hear and see the unit's trouble indication. This output is activated in tandem with the buzzer output of the SG-System I. Once the buzzer has been silenced or has otherwise ended, then output too must also deactivate.

**Output 2 - PIN 9 - Trouble Output**

- This output is used to provide the user with the ability to position the receiver in a remote location and continue to be able to hear and see the unit's trouble indication. This output is activated by the trouble status output of the SG-System I. Any non-masked trouble condition on the system will activate the output. Once all trouble conditions have been cleared then the output will also deactivate.

**Output 3 - PIN 11 - Network Status Output**

- This output is used to provide the user with the ability to position the receiver in a remote location and continue to be able to hear and see the unit's trouble indication in the event of a lost network connection. This output is usually active - that is, relay energised - and will deactivate if the Ethernet connection to the unit fails.

**B**



# C Compatible IP Formats

---

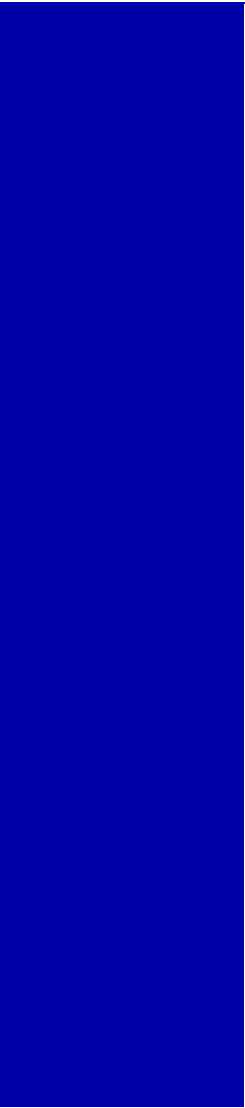

**Table 40: Compatible IP Communicators and Formats**

Transmitter type	Version supported	Formats supported
TL250	v1.00 - v1.4X	SIA
TL250DV	v1.10 - v1.4X	SIA DVAC
TL300	v1.20 - v1.4X	SIA Contact ID (four- and ten-digit account code lengths)
TL150	v1.00 - v1.09	SIA
GS3055	v2.XX	Contact ID (four- and ten-digit account code lengths)
GS3060	v3.XX	Contact ID (four- and ten-digit account code lengths)



# D Printer Words

---

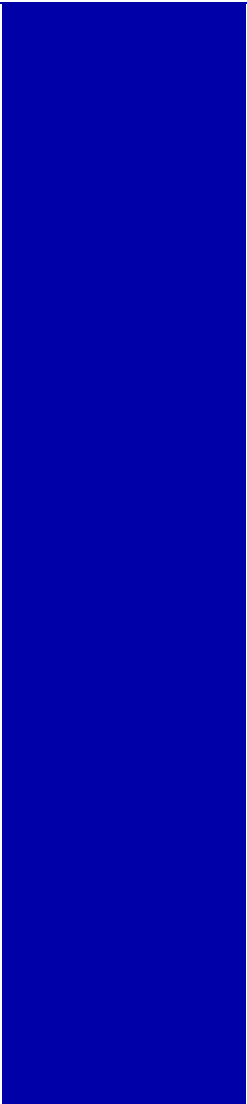

Table 41: Printer Words

Hex #	Printer Words	Hex#	Printer Words	Hex#	Printer Words
00	MEDICAL*	56	PANEL PROGRAM CHANGED	AC	SUCCESSFUL DOWNLOAD ACCESS
01	PENDANT TRANSMITTER	57	SELF-TEST FAILURE	AD	UNSUCCESSFUL ACCESS
02	FAIL TO REPORT IN	58	SYSTEM SHUTDOWN	AE	SYSTEM SHUTDOWN
03	RESERVED	59	BATTERY TEST FAILURE	AF	DIALER SHUTDOWN
04	RESERVED	5A	GROUND FAULT	B0	SUCCESS FULL UPLOAD
05	RESERVED	5B	BATTERY MISSING/DEAD	B1	RESERVED
06	RESERVED	5C	POWER SUPPLY OVERCURRENT	B2	RESERVED
07	RESERVED	5D	ENGINEER RESET	B3	RESERVED
08	RESERVED	5E	RESERVED	B4	RESERVED
09	RESERVED	5F	RESERVED	B5	ACCESS DENIED
0A	FIRE ALARM	60	RESERVED	B6	ACCESS REPORT BY USER
0B	SMOKE	61	RESTORE ALARM	B7	FORCED ACCESS
0C	COMBUSTION	62	OPENING ALARM	B8	EGRESS DENIED
0D	WATER FLOW	63	CLOSING ALARM	B9	EGRESS GRANTED
0E	HEAT	64	SOUNDER/RELAY	BA	ACCESS
0F	PULL STATION	65	BELL 1	BB	ACCESS
10	DUCT	66	BELL 2	BC	ACCESS
11	FLAME	67	ALARM RELAY	BD	ACCESS
12	NEAR FIRE ALARM	68	TROUBLE RELAY	BE	RESERVED
13	RESERVED	69	REVERSING	BF	ARMED STAY
14	PANIC ALARM	6A	NOTIFICATION APPLIANCE 3 CHECK	C0	KEYSWITCH ARMED STAY
15	DURESS ALARM	6B	NOTIFICATION APPLIANCE 4 CHECK	C1	RESERVED
16	SILENT ALARM	6C	RESERVED	C2	RESERVED
17	AUDIBLE ALARM	6D	RESERVED	C3	RESERVED
18	DURESS	6E	SYSTEM PERIPHERAL	C4	RESERVED
19	DURESS	6F	POLLING LOOP OPEN	C5	RESERVED
1A	RESERVED	70	POLLING LOOP SHORT	C6	GROUP CLOSING
1B	RESERVED	71	EXPANSION MODULE FAILURE	C7	GROUP OPENING
1C	RESERVED	72	REPEATER FAILURE	C8	EXCEPTION O/C
1D	RESERVED	73	LOCAL PRINTER PAPER OUT	C9	EARLY O/C
1E	BURGLARY	74	LOCAL PRINTER FAILURE	CA	LATE O/C
1F	PERIMETER	75	EXPANSION MODULE DC LOSS	CB	FAIL TO O/C
20	INTERIOR	76	EXPANSION MODULE LOW BATTERY	CC	FAIL TO O/C
21	24 HOUR	77	EXPANSION MODULE RESET	CD	AUTO ARM FAIL
22	ENTRY/EXIT	78	RESERVED	CE	O/C PARTIAL ARMED
23	DAY/NIGHT	79	EXP. MODULE TAMPER	CF	EXIT ERROR
24	OUTDOOR	7A	EXP. MODULE AC LOSS	D0	USER PRESENT
25	TAMPER	7B	EXP. MODULE SELF-TEST FAIL	D1	RECENT CLOSE
26	NEAR BURGLARY ALARM	7C	LOSS SUPERVISORY RF	D2	SOUNDER/RELAY DISABLED
27	INTRUSION VERIFIER	7D	RESERVED	D3	BELL 1 DISABLE
28	GENERAL ALARM	7E	RESERVED	D4	BELL 2 DISABLE
29	POLLING LOOP OPEN	7F	RESERVED	D5	ALARM RELAY DISABLE
2A	POLLING LOOP SHORT	80	RESERVED	D6	TROUBLE RELAY DISABLE
2B	EXPANSION MODULE FAILURE	81	RESERVED	D7	REVERSING RELAY DISABLE
2C	SENSOR TAMPER	82	COMMUNICATION	D8	NOTIFICATION APPLIANCE 3 DISABLED

**D**

2D	EXPANSION MODULE TAMPER	83	TELCO 1 FAULT	D9	NOTIFICATION APPLIANCE 4 DISABLED
2E	SILENT BURG	84	TELCO 2 FAULT	DA	RESERVED
2F	SENSOR SUPERVISION FAILURE	85	LONG RANGE RADIO	DB	RESERVED
30	RESERVED	86	FAIL TO COMMUNICATE	DC	RESERVED
31	RESERVED	87	LOSS OF RADIO SUPERVISION	DD	DIALER DISABLED
32	24 HOUR NON-BURGLARY	88	LOSS OF CENTRAL POLLING	DE	RADIO TRANSMITTER DISABLED
33	GAS DETECTED*	89	VSWR	DF	REMOTE UPLOAD/DOWNLOAD DISABLED
34	REFRIGERATION*	8A	RESERVED	E0	RESERVED
35	LOSS OF HEAT*	8B	RESERVED	E1	RESERVED
36	WATER LEAKAGE*	8C	PROTECTION LOOP	E2	RESERVED
37	FOIL BREAK*	8D	PROTECTION LOOP OPEN	E3	RESERVED
38	DAY TROUBLE	8E	PROTECTION LOOP SHORT	E4	MESSAGE
39	LOW BOTTLED GAS LEVEL *	8F	FIRE TROUBLE	E5	SERVICE
3A	HIGH TEMPERATURE*	90	EXIT ALARM	E6	ZONE BYPASS
3B	LOW TEMPERATURE*	91	PANIC ZONE TROUBLE	E7	FIRE BYPASS
3C	RESERVED	92	HOLDUP ZN TROUBLE	E8	24 HOUR ZONE BYPASS
3D	LOSS OF AIR FLOW*	93	SWINGER TROUBLE	E9	BURGLARY BYPASS
3E	CARBON MONOXIDE*	94	CROSS ZONE TROUBLE	EA	GROUP BYPASS
3F	TANK LEVEL*	95	RESERVED	EB	SWINGER BYPASS
40	RESERVED	96	SENSOR TROUBLE	EC	ACCESS ZN SHUNT
41	RESERVED	97	LOSS OF SUPERVISORY - RF	ED	ACCESS POINT BYPASS
42	RESERVED	98	LOSS OF SUPERVISORY - RPM	EE	RESERVED
43	RESERVED	99	SENSOR TAMPER	EF	UNBYPASS
44	RESERVED	9A	RF TRANSMITTER. LOW BATTERY	F0	RESERVED
45	RESERVED	9B	SMOKE HI-SENSOR	F1	MANUAL TRIGGER TEST
46	FIRE SUPERVISORY	9C	SMOKE LOW-SENSOR	F2	PERIODIC TEST REPORT
47	LOW WATER PRESSURE*	9D	INTRUSION HI-SENSOR	F3	PERIODIC RF TRANSMISSION
48	LOW CO2*	9E	INTRUSION LOW-SENSOR	F4	FIRE TEST
49	GATE VALVE SENSOR*	9F	SELF TEST FAIL	F5	STATUS REPORT TO FOLLOW
4A	LOW WATER LEVEL*	A0	OPEN/CLOSE	F6	LISTEN-IN TO FOLLOW
4B	PUMP ACTIVATED*	A1	O/C BY USER	F7	WALK TEST MODE
4C	PUMP FAILURE*	A2	GROUP O/C	F8	OFF NORMAL CONDITION
4D	RESERVED	A3	AUTOMATIC O/C	F9	VIDEO TRANSMITTER ACTIVE
4E	RESERVED	A4	LATE O/C	FA	RESERVED
4F	RESERVED	A5	DEFERRED O/C	FB	FIRE POINT TEST
50	SYSTEM TROUBLE	A6	CANCEL	FC	FIRE POINT NOT TESTED
51	AC LOSS	A7	REMOTE ARM/DISARM	FD	INTRUSION ZONE WALK TESTED
52	LOW SYSTEM BATTERY	A8	QUICK ARM	FE	FIRE ZONE WALK TESTED
53	RAM CHECKSUM BAD	A9	KEYSWITCH O/C	FF	PANIC ZONE WALK TESTED
54	ROM CHECKSUM BAD	AA	RESERVED		
55	SYSTEM RESET	AB	CALLBACK REQUEST MADE		

**D**





# E Profiles

---



## Profiles

The SG-System I virtual receiver will load unique profiles in order to effectively communicate with control panels. A profile is a set of pre-programmed line card options unique to a particular DNIS or Caller ID number. The DNIS will point to a particular profile, which will then be loaded into the line card before the first handshake is sent. It is essential that the correct option be programmed for a profile in order to communicate correctly with the control panel. Each virtual receiver can have a maximum of 64 profiles (0 to 63). To change the options for a particular profile, the System I Console software is provided. This software will allow the user/operator to edit the profiles. Should a signal be received that has a DNIS that is *not* associated to a profile, the receiver will use profile 0. The SG-System I has a pool of profiles that can be used by either channel. Profiles are not reserved to a channel.

DNIS (Dialled Number Identification Service): This number represents the dialled number, or the number being called.

ANI (Automatic Number Identification) This number represents the source of a call and allows the system to determine the handshake protocol.

Caller ID: This number identifies the source of a call.

DNIS or Caller ID can be used for profile selection.

**Figure 12: Profiles**

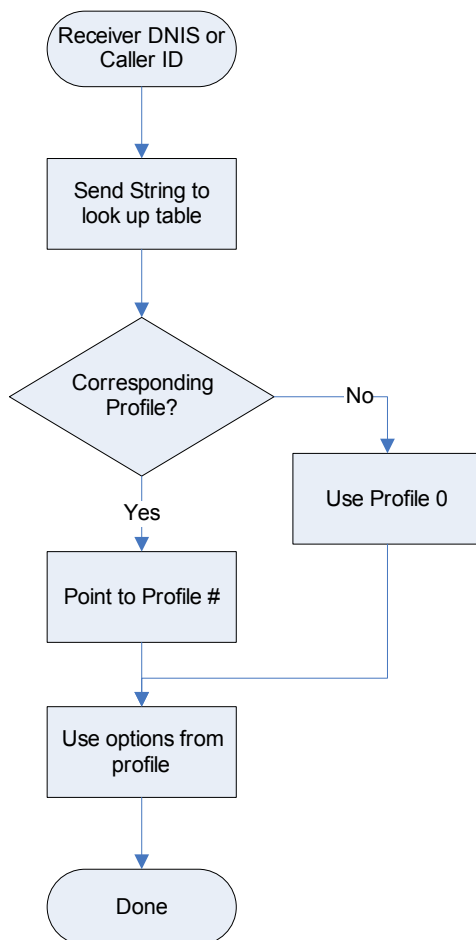

Each profile is made up of Static Options (Options 101 - 12F) and Dynamic Options (Options 130 - 1B2). The static options are the same for all profiles; the dynamic options can be programmed specifically as per hunt groups, panel type, etc.

By receiving the DNIS or Caller ID, the appropriate profile can be selected through a look-up table stored on the line card. Profile 0 is the default. When no Caller ID or an unknown DNIS is received, or when the received number does not point to a profile, the default will be used.

Profiles are used to reduce on-line time, and for specific customers or panel/format types you can have a profile with certain handshakes sent first. In addition, some formats require certain options, and this too can be pre-defined.

Profiles allow for a more customized system. Rather than having a line card (or the receiver itself) devoted to certain customers (panel/format types), the System I can handle any format at any time through the use of profiles. Each line card holds its own look-up table that can be shared through line pools, or shared within the entire receiver. Two types of tables are available, but only one type can be chosen. The first type, which consists of 10 000 entries, is used strictly with DNIS of up to five digits.

**Table type 1:**

DNIS received Profile # to be used

DNIS Received	Profile # to be used
00001	01
00002	03
00003	24
...	...
99999	45

**Table type 2:**

The second type is used if ANI-Caller ID and/or DNIS are received, and can consist of up to 5000 entries, with Caller ID or DNIS of up to 10 digits.

Each portion may contain 0-10000 entries with the total of all the entries not exceeding 10 000. The receiver will first check through the Caller ID section if a Caller ID number is received. If only a DNIS number is received, or Caller ID is received but the Caller ID was not found, it will check in the DNIS section. On a standard receiver, the Automation output would look similar to the following:

```
1RLLLLssssssAAAAsYsZZ[DC4]
```

On the System I, it will replace the RLLLL, which is normally the receiver number and the line card number, with the DNIS received or the convert data found in the table. This makes possible the duplication of accounts, as long as they are dialling different numbers. The output will become:

```
1DDDDDssssssAAAAsYsZZ[DC4]
```

Where DDDDD is the DNIS number. See Option 044 for more information on how to enable the combined table.

**E**



**Technical Support: 1-800-387-3630 (Canada / US)**  
**905-760-3000 (International)**  
**www.dsc.com**



**© 2008 Digital Security Controls**